

Part number

MBO 10.40



Hood, BIG series, with 4 pegs, M40 side cable entry, size "57.27"

Product description		Material properties	
Product type	Hood	Other materials	Gasket: NBR
Series	BIG	Colour	RAL 7040 grey
Closing type	With 4 pegs	RoHs conformity	Compliant
Size	Size 57.27	China RoHs - EFUP	E
Cable entry	Side cable entry M40	REACH SVHC substances	No
Technical data		Approvals / Standards	
IP degree of protection	IP66	Certifications	DNV, BV
Further technical details		UL	ECBT2
Weight	440,00 g	cUL	ECBT8
Operating temperature range (min, max)	-40°C...+125°C	General ordering information	
		EAN13 code	8015747187169
		eCl@ss 8.1	27440202
		ETIM 7.0	EC000437
		Packaging Information	
		Packaging length	205,00 mm
		Packaging height	135,00 mm
		Packaging width	135,00 mm
		Packaging weight	1,89 kg
		Packaging volume	3,74 dm ³
		Packaging description	Carton box
		Packaging quantity	4 Pcs
		Packaging EAN code	8015747188746
		Sub-packaging weight	0,47 kg
		Sub-packaging description	Plastic packaging
		Sub-packaging quantity	1 Pcs
		Sub-packaging EAN barcode	8015747035880

Part number

MBO 10.40



Catalogue drawings

MBO 10

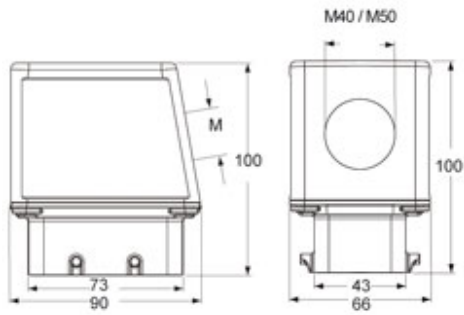

Catalogue drawings

