

Part number

# MAV 24 L40



Hood, C-TYPE series, with 2 pegs, M40 top cable entry, size "104.27", high construction

Product description		Material properties	
Product type	Hood	Colour	RAL 7040 grey
Series	C-TYPE	RoHs conformity	Compliant
Closing type	With 2 pegs	China RoHs - EFUP	E
Size	Size 104.27	REACH SVHC substances	No
Cable entry	Top cable entry M40	Approvals / Standards	
Specification	High construction	Certifications	DNV, BV
Technical data		UL	ECBT2
IP degree of protection	IP65 / IP66 / IP69	cUL	ECBT8
Further technical details		General ordering information	
Weight	215,00 g	EAN13 code	8015747052740
Operating temperature range (min, max)	-40°C...+125°C	eCl@ss 8.1	27440202
		ETIM 7.0	EC000437
		Packaging Information	
		Packaging length	245,00 mm
		Packaging height	165,00 mm
		Packaging width	215,00 mm
		Packaging weight	2,37 kg
		Packaging volume	8,69 dm <sup>3</sup>
		Packaging description	Carton box
		Packaging quantity	10 Pcs
		Packaging EAN code	8015747259316
		Sub-packaging weight	1,19 kg
		Sub-packaging description	Plastic packaging
		Sub-packaging quantity	5 Pcs
		Sub-packaging EAN barcode	8015747052757

Part number

# MAV 24 L40



Catalogue drawings

**CHO L (CAO L) - MHO L [MAO L]**  
**CHV L [CAV L] - MHV L (MAV L)**

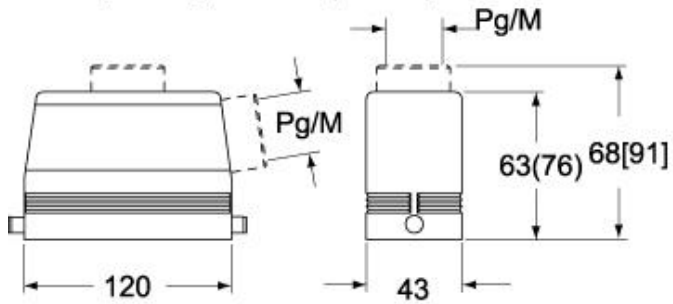

**CHV LG (CAV LG), MHV LG (MAV LG) [MFV LG]**

