

Part number

JCVP 06 L



Surface mounting housing, JEI®-V series, with 1 lever, Pg16 cable entry, size "44.27"

Product description

Product type	Surface mounting housing
Series	JEI®-V
Closing type	With 1 lever
Size	Size 44.27
Cable entry	With cable entry Pg16

Technical data

IP degree of protection IP65 / IP66 / IP69

Further technical details

Weight	209,00 g
Operating temperature range (min, max)	-40°C...+125°C

Material properties

Other materials	Lever: Galvanized steel Gasket: NBR
Colour	RAL 7040 grey

Approvals / Standards

Certifications	DNV, BV
UL	ECBT2
cUL	ECBT8

General ordering information

EAN13 code 8015747137652

Packaging Information

Packaging length	285,00 mm
Packaging height	170,00 mm
Packaging width	190,00 mm
Packaging weight	4,18 kg
Packaging volume	9,21 dm ³
Packaging description	Carton box
Packaging quantity	20 Pcs
Packaging EAN code	8015747144070
Sub-packaging weight	1,05 kg
Sub-packaging description	Plastic packaging
Sub-packaging quantity	5 Pcs
Sub-packaging EAN barcode	8015747140256

Part number

JCVP 06 L



Catalogue drawings

JCVP L

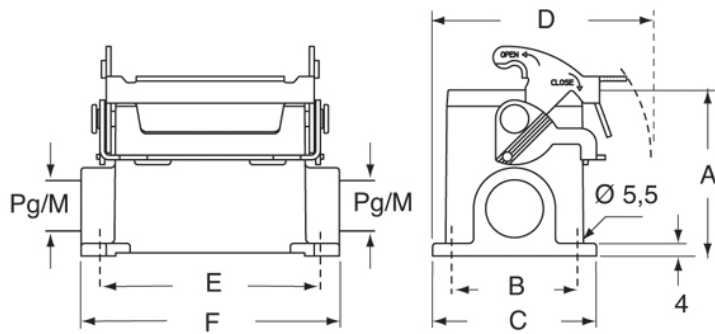

	A	B	C	D	E	F
JCVP 06 L	53	40	52	70	70	82
JCVP 10 L	57	40	52	73	82	93,5
JCVP 16 L	63	45	57	75,5	105	117
JCVP 24 L	63	45	57	75,5	132	144