

Part number
JCVI 24 LP



Bulkhead mounting housing, JEI®-V series,
 with 1 lever, size "104.27", with plastic cover

Product description	
Product type	Bulkhead mounting housing
Series	JEI®-V
Closing type	With 1 lever
Size	Size 104.27
Cable entry	Without cable entry
Specification	With plastic cover
Technical data	
IP degree of protection	IP65
Further technical details	
Weight	203,60 g
Operating temperature range (min, max)	-40°C...+125°C

Material properties	
Other materials	Lever: Galvanized steel Gasket: NBR
Colour	RAL 7040 grey
Approvals / Standards	
Certifications	DNV, BV
UL	ECBT2
cUL	ECBT8
General ordering information	
EAN13 code	8015747137720
Packaging Information	
Packaging length	475,00 mm
Packaging height	220,00 mm
Packaging width	200,00 mm
Packaging weight	4,75 kg
Packaging volume	20,90 dm ³
Packaging description	Carton box
Packaging quantity	20 Pcs
Packaging EAN code	8015747144032
Sub-packaging weight	1,19 kg
Sub-packaging description	Plastic packaging
Sub-packaging quantity	5 Pcs
Sub-packaging EAN barcode	8015747140232

Part number
JCVI 24 LP



Catalogue drawings

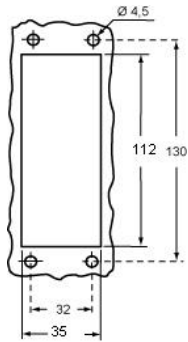

Catalogue drawings

JCVI LP

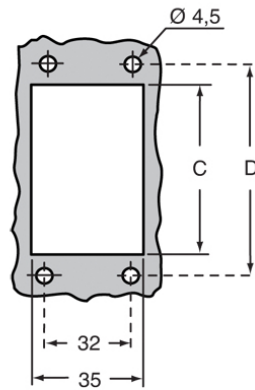
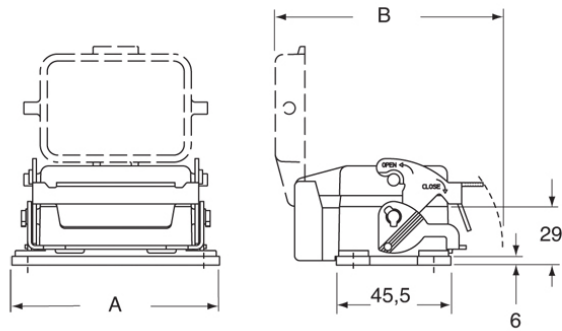

	A	B	C	D
JCVI 06 LP	82,5	89	52	70
JCVI 10 LP	95,5	94	65	83
JCVI 16 LP	115,5	94	86	103
JCVI 24 LP	142,5	94	112	130