

Part number

FM 3251 PI



Box system for socket-outlet combinations, FM series, for inclined flush-mounting sockets, 6 openings

Product description

Product type	Box system for socket-outlet combinations
Series	FM
Size	320 x 510 x 135 mm
Specification	For inclined flush-mounting sockets 6 openings

Technical data

IP degree of protection IP55

Further technical details

Weight	2.672,00 g
Operating temperature range (min, max)	-40°C ... +125°C

Material properties

Colour RAL 7035 grey

General ordering information

EAN13 code 8015747047661

Packaging Information

Packaging length	530,00 mm
Packaging height	160,00 mm
Packaging width	340,00 mm
Packaging weight	3,00 kg
Packaging volume	28,83 dm ³
Packaging description	Carton box
Packaging quantity	1 Pcs
Packaging EAN code	8015747047678

Part number

FM 3251 PI



Catalogue drawings

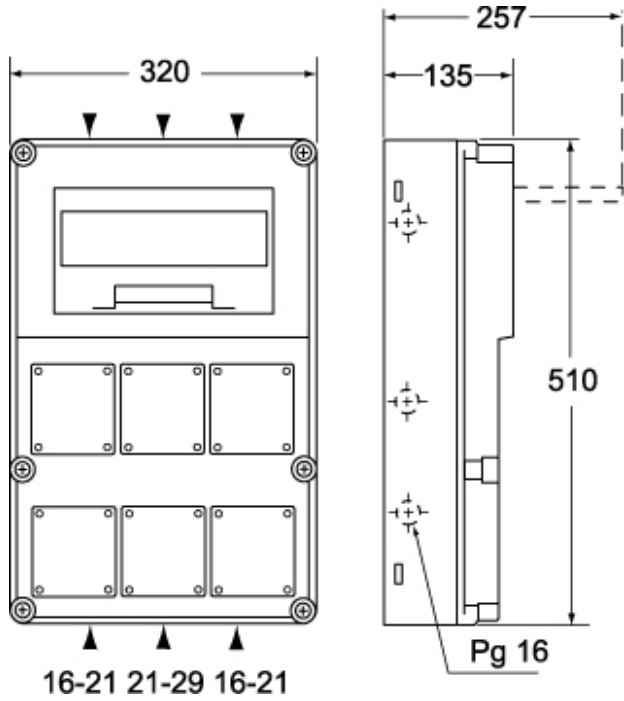

Catalogue drawings

