

Part number

FC 2814 DB5



Box, FC series, with fixed cover, for 2 FC 1453 TB plates

Product description

Product type	Box
Series	FC
Specification	With fixed cover For 2 FC 1453 TB plates

Technical data

IP degree of protection	IP55
--------------------------------	------

Further technical details

Weight	621,00 g
---------------	----------

Material properties

Colour	RAL 7035 grey
---------------	---------------

General ordering information

EAN13 code	8015747046541
-------------------	---------------

Packaging Information

Packaging length	360,00 mm
Packaging height	165,00 mm
Packaging width	315,00 mm
Packaging weight	2,85 kg
Packaging volume	18,71 dm ³
Packaging description	Carton box
Packaging quantity	4 Pcs
Packaging EAN code	8015747046558
Sub-packaging weight	0,71 kg
Sub-packaging description	Plastic bag
Sub-packaging quantity	1 Pcs
Sub-packaging EAN barcode	8015747046565

Part number

FC 2814 DB5



Catalogue drawings

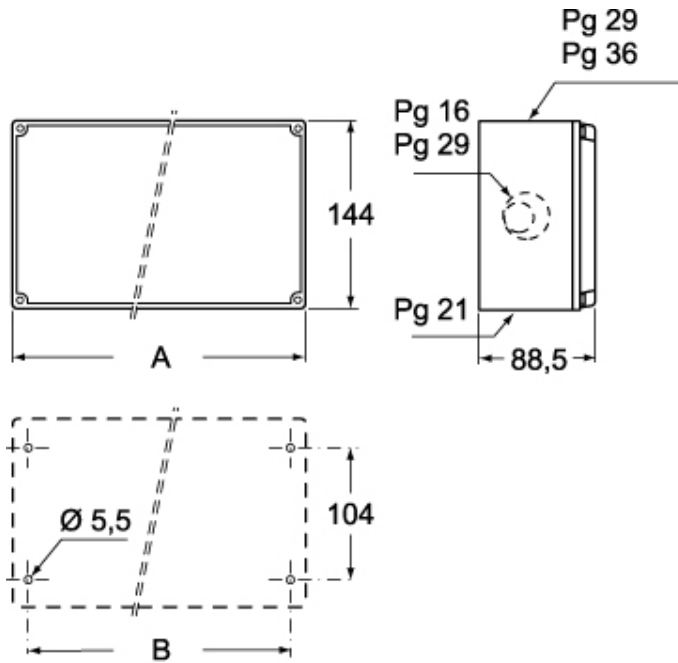

	A	B
FC 2214 DB5	228	210
FC 2514 DB5	260	239
FC 2814 DB5	290	269