

Part number

# FC 1414 DB



Box, FC series, with fixed cover, for FC 1453 TB plate

#### Product description

<b>Product type</b>	Box
<b>Series</b>	FC
<b>Specification</b>	With fixed cover For FC 1453 TB plate

#### Technical data

**IP degree of protection** IP44

#### Further technical details

<b>Weight</b>	370,00 g
<b>Operating temperature range (min, max)</b>	-40°C ... +125°C

#### Material properties

**Colour** RAL 7035 grey

#### General ordering information

**EAN13 code** 8015747045438

#### Packaging Information

<b>Packaging length</b>	335,00 mm
<b>Packaging height</b>	320,00 mm
<b>Packaging width</b>	400,00 mm
<b>Packaging weight</b>	8,40 kg
<b>Packaging volume</b>	42,88 dm <sup>3</sup>
<b>Packaging description</b>	Carton box
<b>Packaging quantity</b>	20 Pcs
<b>Packaging EAN code</b>	8015747045445
<b>Sub-packaging weight</b>	0,42 kg
<b>Sub-packaging description</b>	Plastic packaging
<b>Sub-packaging quantity</b>	1 Pcs
<b>Sub-packaging EAN barcode</b>	8015747113199

Part number

# FC 1414 DB



Catalogue drawings

## FC 1114 DB/DB5

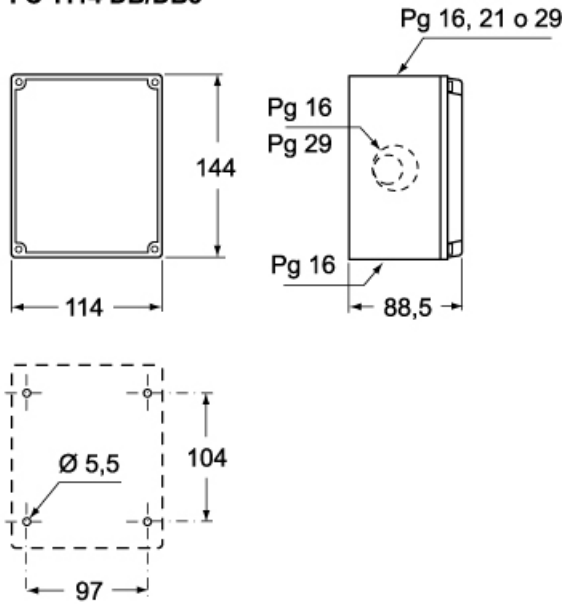

## FC 1414 DB/DB5

