

Part number

CX 08 CYF



Female modular insert, Mixo series, AXYR® spring push-in terminal connection without tools, 8 poles, 1 module, 16 A 400 V 6 kV 3

Product description

Product type	Modular insert
Series	Mixo
Connection type	AXYR® high density spring terminal connection without tools
Gender	Female
N. of poles	8 poles
Size	1 module

Technical data

Current	16 A
Voltage	400 V
Rated impulse withstand voltage	6 kV
Pollution degree	3
Rated voltage according to UL/CSA	600 V
Wire cross-section	0,25 mm ² - 4,00 mm ²
AWG size	24 - 12
Contact type	Turned silver plated
IP degree of protection	IP20 without enclosure, IP65/IP66/IP68/IP69 with enclosure

Further technical details

Characteristics according to EN 61984	16 A 400 V 6 kV 3
Mating cycles	≥ 500
Insulation resistance	≥ 10 GΩ
Contact resistance	≤ 3 mΩ
Weight	23,50 g
Operating temperature range (min, max)	-40 °C ... +125 °C
Conductors stripping length	9...11 mm
UL 94 flammability rating	V-0

Material properties

Main material	Polycarbonate (PC)
Other materials	Contacts: copper alloy
Colour	RAL 7032 grey
RoHs conformity	Compliant with exemption 6(c): copper alloy containing up to 4% lead by weight
China RoHs - EFUP	50
REACH SVHC substances	Yes Lead

General ordering information

EAN13 code	8015747284295
eCl@ss 8.1	27440205
ETIM 7.0	EC000438

Packaging Information

Packaging length	220,00 mm
Packaging height	130,00 mm
Packaging width	240,00 mm
Packaging weight	1,85 kg
Packaging volume	6,86 dm ³
Packaging description	Carton box
Packaging quantity	60 Pcs
Packaging EAN code	8015747284301
Sub-packaging weight	0,03 kg
Sub-packaging description	Plastic bag
Sub-packaging quantity	1 Pcs
Sub-packaging EAN barcode	8015747139892

Part number

CX 08 CYF



Catalogue drawings

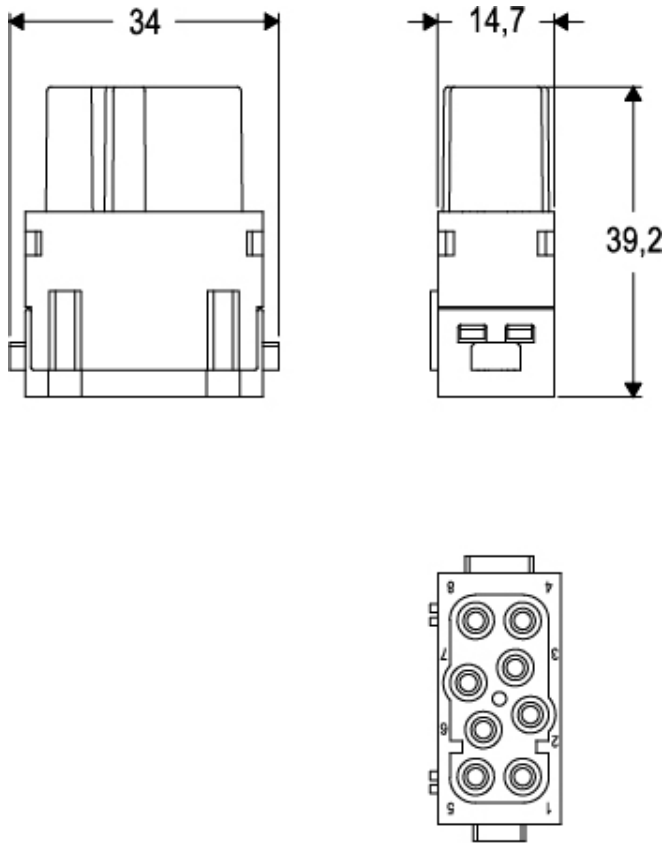

Derating curves

CX..CY 8 poles connector inserts
Maximum current load derating diagram

