

Part number

CX 02 PDF



Docking frame, fixed-mount, 2 modules, size 44.27

Product description

Product type	Docking frame
Size	Size 44.27
Specification	For 2 modular inserts and enclosures size 44.27

Technical data

IP degree of protection	IP20
--------------------------------	------

Further technical details

Mating cycles	≥ 500 ≥ 10000 (MIXO units with HNM contacts)
Weight	1,00 g
Operating temperature range (min, max)	-40°C ... +125°C
UL 94 flammability rating	V-0

Material properties

Main material	Polycarbonate (PC)
Colour	RAL 7032 grey
RoHs conformity	Compliant
China RoHs - EFUP	E
REACH SVHC substances	No

General ordering information

EAN13 code	8015747303170
eCl@ss 8.1	27440210
ETIM 7.0	EC002310

Packaging Information

Packaging description	Carton box
Packaging quantity	10 Pcs
Packaging EAN code	8015747303194
Sub-packaging description	Plastic bag
Sub-packaging quantity	1 Pcs
Sub-packaging EAN barcode	8015747303200

Part number

CX 02 PDF



Catalogue drawings

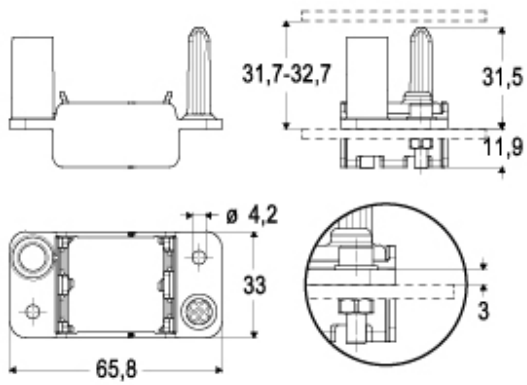

Catalogue drawings

