

Part number

CRQ 21-1



Semi-cable gland, Pg21, for diameter 7-18 mm, for CQ 08 V and VG enclosures

Product description

Product type	Semi-cable gland
Cable entry	Pg21
Specification	for diameter 7-18 mm For CQ 08 V and VG enclosures

Further technical details

Weight	7,00 g
Operating temperature range (min, max)	-40°C ... +125°C

Material properties

Main material	Polyamide (PA)
Other materials	Gasket: NBR
Colour	RAL 9005 black

General ordering information

EAN13 code	8015747167192
-------------------	---------------

Packaging Information

Sub-packaging weight	0,04 kg
Sub-packaging description	Plastic bag
Sub-packaging quantity	5 Pcs
Sub-packaging EAN barcode	8015747262088

Part number

CRQ 21-1



Catalogue drawings

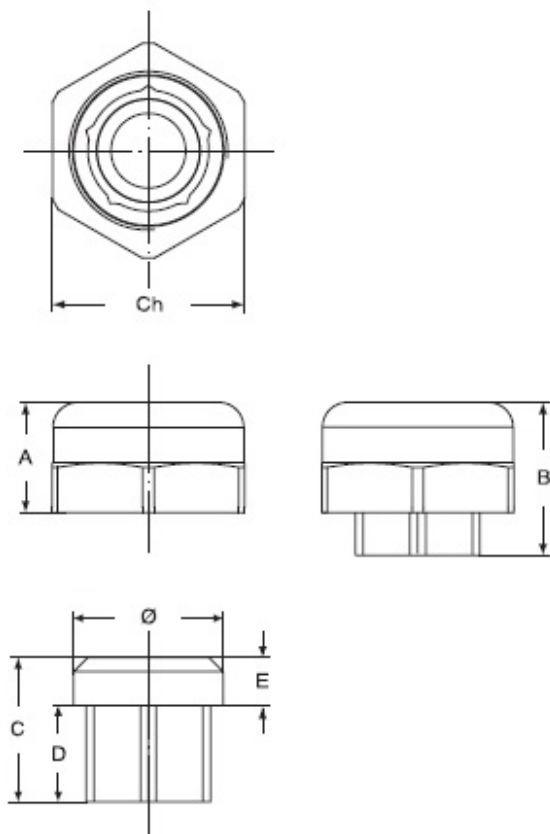

part No.	A	B	C	D	E	Ø	Ch
CRQ 16	15,5	21,5	20,25	13,5	6,75	21	27
CRQ 21	18,2	27,5	25	15,5	9	26,5	33