

Part number

CMV 03 X



Hood, 830V series, with 2 levers, Pg16 top cable entry, size "57.27", without gasket

Product description

Product type	Hood
Series	830V
Closing type	With 2 levers
Size	Size 57.27
Cable entry	Top cable entry Pg16
Specification	Without gasket

Technical data

IP degree of protection	IP65 / IP66 / IP69
--------------------------------	--------------------

Further technical details

Weight	203,70 g
Operating temperature range (min, max)	-40°C...+125°C

Material properties

Colour	RAL 7040 grey
RoHs conformity	Compliant
China RoHs - EFUP	E
REACH SVHC substances	No

Approvals / Standards

Certifications	DNV, BV
UL	ECBT2
cUL	ECBT8

General ordering information

EAN13 code	8015747031806
-------------------	---------------

Packaging Information

Sub-packaging weight	1,02 kg
Sub-packaging description	Plastic packaging
Sub-packaging quantity	5 Pcs
Sub-packaging EAN barcode	8015747031813

Part number

CMV 03 X



Catalogue drawings

CMO X (CMAO X) - MMO X (MMAO X)

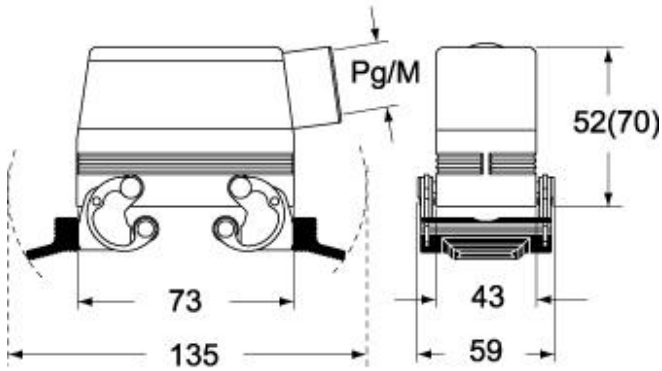

CMV X (CMAV X) - MMV X (MMAV X)

