

Part number

# CMAF 16.21



Hood, 830V series, with 4 pegs, Pg21 frontal cable entry, size "104.27", high construction

#### Product description

<b>Product type</b>	Hood
<b>Series</b>	830V
<b>Closing type</b>	With 4 pegs
<b>Size</b>	Size 104.27
<b>Cable entry</b>	Frontal cable entry with adapter Pg21
<b>Specification</b>	High construction

#### Technical data

**IP degree of protection** IP65 / IP66 / IP69

#### Further technical details

<b>Weight</b>	276,00 g
<b>Operating temperature range (min, max)</b>	-40°C...+125°C

#### Material properties

<b>Colour</b>	RAL 7040 grey
<b>RoHs conformity</b>	Compliant with exemption 6(c): copper alloy containing up to 4% lead by weight
<b>China RoHs - EFUP</b>	50
<b>REACH SVHC substances</b>	Yes Lead
<b>SCIP number</b>	15deaf78-e939-4401-a0b0-e2228ca32a03

#### Approvals / Standards

<b>Certifications</b>	DNV, BV
<b>UL</b>	ECBT2
<b>cUL</b>	ECBT8

#### General ordering information

**EAN13 code** 8015747028615

#### Packaging Information

<b>Sub-packaging weight</b>	1,38 kg
<b>Sub-packaging description</b>	Plastic packaging
<b>Sub-packaging quantity</b>	5 Pcs
<b>Sub-packaging EAN barcode</b>	8015747104159

Part number

# CMAF 16.21



Catalogue drawings

**CMO [CMAO] CMV (CMAV) - MMO [MMAO]  
MMV (MMAV)**

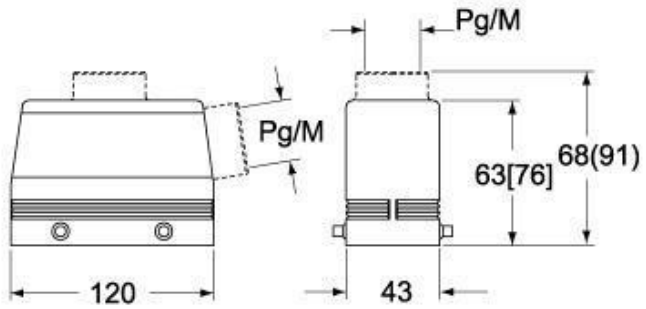

**CMV G (CMAV G) - MMV G (MMAV G) - [MMFV G]**

