

Part number

# CHV 32.29



Hood, C-TYPE series, with 4 pegs, Pg29 top cable entry, size "77.62"

#### Product description

<b>Product type</b>	Hood
<b>Series</b>	C-TYPE
<b>Closing type</b>	With 4 pegs
<b>Size</b>	Size 77.62
<b>Cable entry</b>	Top cable entry with adapter Pg29

#### Technical data

<b>IP degree of protection</b>	IP65 / IP66 / IP69
--------------------------------	--------------------

#### Further technical details

<b>Weight</b>	410,00 g
<b>Operating temperature range (min, max)</b>	-40°C...+125°C

#### Material properties

<b>Colour</b>	RAL 7040 grey
<b>RoHs conformity</b>	Compliant with exemption 6(c): copper alloy containing up to 4% lead by weight
<b>China RoHs - EFUP</b>	50
<b>REACH SVHC substances</b>	Yes Lead
<b>SCIP number</b>	15deaf78-e939-4401-a0b0-e2228ca32a03

#### Approvals / Standards

<b>Certifications</b>	DNV, BV
<b>UL</b>	ECBT2
<b>cUL</b>	ECBT8

#### General ordering information

<b>EAN13 code</b>	8015747025126
-------------------	---------------

#### Packaging Information

<b>Packaging length</b>	370,00 mm
<b>Packaging height</b>	140,00 mm
<b>Packaging width</b>	210,00 mm
<b>Packaging weight</b>	3,51 kg
<b>Packaging volume</b>	10,88 dm <sup>3</sup>
<b>Packaging description</b>	Carton box
<b>Packaging quantity</b>	8 Pcs
<b>Packaging EAN code</b>	8015747025133
<b>Sub-packaging weight</b>	0,44 kg
<b>Sub-packaging description</b>	Plastic packaging
<b>Sub-packaging quantity</b>	1 Pcs
<b>Sub-packaging EAN barcode</b>	8015747025140

Part number

# CHV 32.29



Catalogue drawings

**CHO - CHV MHO/MFO/MFV - MHV  
MMV (MMAV)**

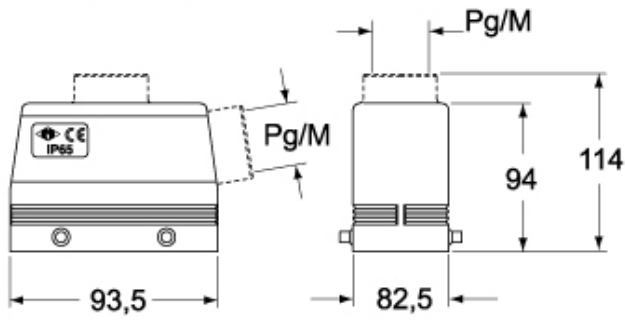

**CHV G - MHV G - MFV G**

