

Part number

CHP 06 LS2



Surface mounting housing, C-TYPE series, with 1 lever, Pg16 x 2 cable entry, size "44.27", with metal cover

Product description

Product type	Surface mounting housing
Series	C-TYPE
Closing type	With 1 lever
Size	Size 44.27
Cable entry	With cable entry Pg16 x 2
Specification	With metal cover

Technical data

IP degree of protection IP65

Further technical details

Weight	255,00 g
Operating temperature range (min, max)	-40°C...+125°C

Material properties

Other materials	Lever: Stainless steel, polyamide (PA) Gasket: NBR
Colour	RAL 7040 grey
RoHs conformity	Compliant
China RoHs - EFUP	E
REACH SVHC substances	No

Approvals / Standards

Certifications	DNV, BV
UL	ECBT2
cUL	ECBT8

General ordering information

EAN13 code 8015747021623

Packaging Information

Packaging length	475,00 mm
Packaging height	160,00 mm
Packaging width	140,00 mm
Packaging weight	2,73 kg
Packaging volume	10,64 dm ³
Packaging description	Carton box
Packaging quantity	10 Pcs
Packaging EAN code	8015747021630
Sub-packaging weight	1,37 kg
Sub-packaging description	Plastic packaging
Sub-packaging quantity	5 Pcs
Sub-packaging EAN barcode	8015747021647

Part number

CHP 06 LS2



Catalogue drawings

CHP L CAP L - MHP L MAP L

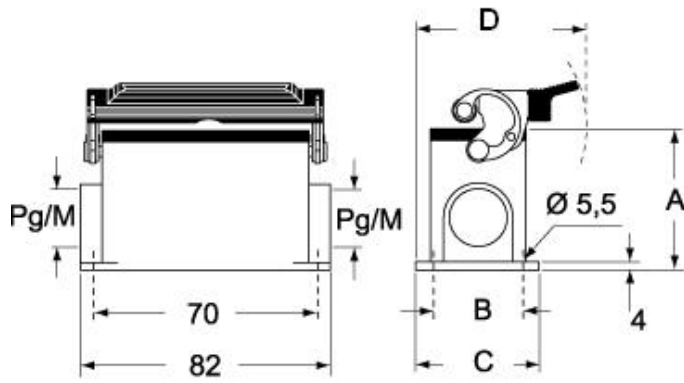

CHP LS CAP LS - MHP LS MAP LS

