

Part number

CGV 16.29



Hood, IP68 series, with 2 screws, Pg29 top cable entry, size "77.27"

Product description

Product type	Hood
Series	IP68
Closing type	With 2 screws
Size	Size 77.27
Cable entry	Top cable entry Pg29

Technical data

IP degree of protection IP66 / IP68 / IP69

Further technical details

Weight	480,00 g
Operating temperature range (min, max)	-40°C...+125°C

Material properties

Main material	Aluminium die-cast
Other materials	Screws: Stainless steel
Colour	RAL 9005 black
RoHs conformity	Compliant
China RoHs - EFUP	E
REACH SVHC substances	No

Approvals / Standards

Certifications	DNV, BV
UL	ECBT2
cUL	ECBT8

General ordering information

EAN13 code 8015747142311

Packaging Information

Packaging length	175,00 mm
Packaging height	135,00 mm
Packaging width	130,00 mm
Packaging weight	1,06 kg
Packaging volume	3,07 dm ³
Packaging description	Carton box
Packaging quantity	2 Pcs
Packaging EAN code	8015747142991
Sub-packaging weight	0,53 kg
Sub-packaging description	Plastic packaging
Sub-packaging quantity	1 Pcs
Sub-packaging EAN barcode	8015747143004

Part number

CGV 16.29



Catalogue drawings

CGO/MGO CGV/MGV

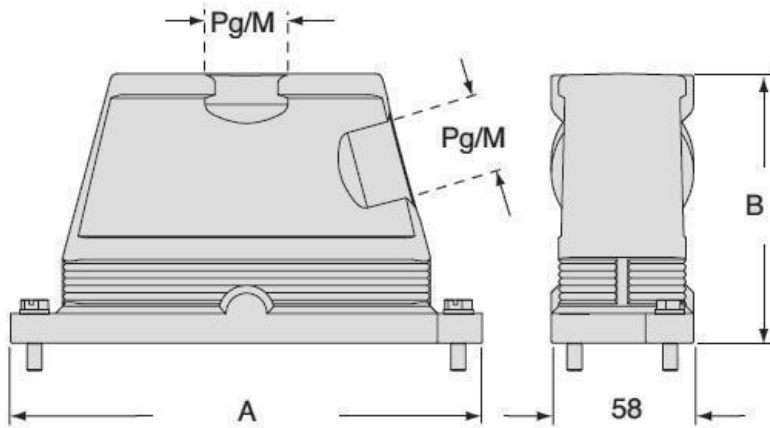

		A	B
CGO/MGO	CGV/MGV 06	133	101
CGO/MGO	CGV/MGV 10	146	101
CGO/MGO	CGV/MGV 16	166	111
CGO/MGO	CGV/MGV 24	193	111