

Part number

# CAPR 16.21



Surface mounting housing, 180 °C series, with 2 levers, Pg21 cable entry, size "77.27", high construction

## Product description

<b>Product type</b>	Surface mounting housing
<b>Series</b>	180 °C
<b>Closing type</b>	With 2 levers
<b>Size</b>	Size 77.27
<b>Cable entry</b>	With cable entry Pg21
<b>Specification</b>	High construction

## Technical data

**IP degree of protection** IP65

## Further technical details

<b>Weight</b>	400,00 g
<b>Operating temperature range (min, max)</b>	-40°C ... +180°C

## Material properties

<b>RoHS conformity</b>	Compliant
<b>China RoHS - EFUP</b>	E
<b>REACH SVHC substances</b>	No
<b>Approvals / Standards</b>	
<b>Certifications</b>	DNV, BV
<b>UL</b>	ECBT2
<b>cUL</b>	ECBT8

## General ordering information

<b>EAN13 code</b>	8015747008693
<b>eCl@ss 8.1</b>	27440202
<b>ETIM 7.0</b>	EC000437

## Packaging Information

<b>Packaging length</b>	475,00 mm
<b>Packaging height</b>	220,00 mm
<b>Packaging width</b>	175,00 mm
<b>Packaging weight</b>	4,50 kg
<b>Packaging volume</b>	18,29 dm <sup>3</sup>
<b>Packaging description</b>	Carton box
<b>Packaging quantity</b>	10 Pcs
<b>Packaging EAN code</b>	8015747248136
<b>Sub-packaging weight</b>	2,25 kg
<b>Sub-packaging description</b>	Plastic packaging
<b>Sub-packaging quantity</b>	5 Pcs
<b>Sub-packaging EAN barcode</b>	8015747008709

Part number

# CAPR 16.21



Catalogue drawings

## CHIR

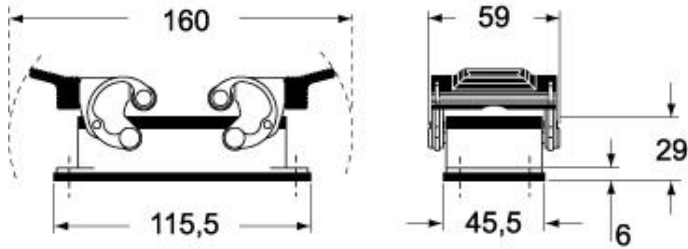

## CAPR - MAPR

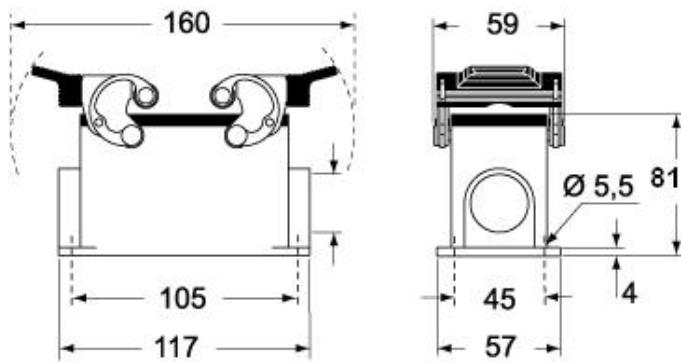

## CHCR

