

Part number  
**BK 3263**



Interlocked switched socket-outlet, BK series,  
 2 poles + PE, 6 h (blue), 32 A, 200 ÷ 250 V,  
 sectionable fuse carrier 10 x 38 mm

Product description	
<b>Product type</b>	Interlocked switched socket-outlet
<b>Series</b>	BK
<b>N. of poles</b>	2 poles +
<b>Clock position</b>	6
<b>Size</b>	Socket centre distance 114 x 228 mm
<b>Specification</b>	Sectionable fuse carrier 10 x 38 mm
Technical data	
<b>Current</b>	32 A
<b>Voltage</b>	200 ÷ 250 V
<b>IP degree of protection</b>	IP67
Further technical details	
<b>Weight</b>	1.333,00 g
<b>Operating temperature range (min, max)</b>	-25°C ... +40°C
<b>IK rating (impact degree of protection)</b>	IK10

Material properties	
<b>Colour</b>	RAL 7035 grey, RAL 5015 blue
<b>RoHs conformity</b>	Compliant with exemption 6(c): copper alloy containing up to 4% lead by weight
<b>China RoHs - EFUP</b>	50
<b>REACH SVHC substances</b>	Yes Lead
<b>SCIP number</b>	F6799547-ab84-42f2-938f-233ba663766d
Approvals / Standards	
<b>Reference standard</b>	EN 60309-1, -2 e -4
General ordering information	
<b>EAN13 code</b>	8015747004848
Packaging Information	
<b>Packaging length</b>	400,00 mm
<b>Packaging height</b>	300,00 mm
<b>Packaging width</b>	400,00 mm
<b>Packaging weight</b>	13,58 kg
<b>Packaging volume</b>	48,00 dm <sup>3</sup>
<b>Packaging description</b>	Carton box
<b>Packaging quantity</b>	9 Pcs
<b>Packaging EAN code</b>	8015747004855
<b>Sub-packaging length</b>	116,00 mm
<b>Sub-packaging height</b>	130,00 mm
<b>Sub-packaging width</b>	230,00 mm
<b>Sub-packaging weight</b>	1,51 kg
<b>Sub-packaging volume</b>	3,47 dm <sup>3</sup>
<b>Sub-packaging description</b>	Carton box
<b>Sub-packaging quantity</b>	1 Pcs
<b>Sub-packaging EAN barcode</b>	8015747004862

Part number

# BK 3263



Catalogue drawings

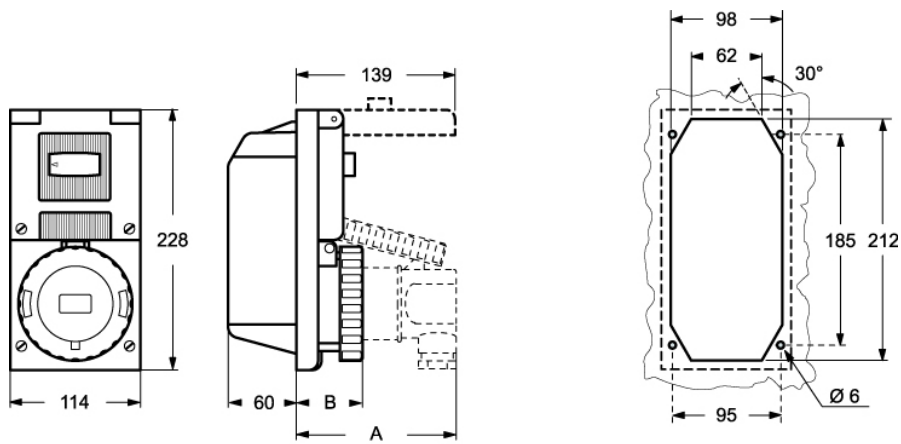

BK		A	B
16A	2P + ⊕	105	50
	3P + ⊕	105	50
	3P + N + ⊕	110	50
32A	2P + ⊕	140	58
	3P + ⊕	140	58
	3P + N + ⊕	140	58