

Part number

BK 1644



Interlocked switched socket-outlet, BK series, 3 poles + PE, 4 h (yellow), 16 A, 100 ÷ 130 V, sectionable fuse carrier 10 x 38 mm

Product description		Material properties	
Product type	Interlocked switched socket-outlet	Colour	RAL 7035 grey, RAL 1021 yellow
Series	BK		Compliant with exemption 6(c): copper alloy containing up to 4% lead by weight
N. of poles	3 poles + 	RoHs conformity	6(c): copper alloy containing up to 4% lead by weight
Clock position	4	China RoHs - EFUP	50
Size	Socket centre distance 114 x 228 mm	REACH SVHC substances	Yes Lead
Specification	Sectionable fuse carrier 10 x 38 mm	SCIP number	F6799547-ab84-42f2-938f-233ba663766d
Technical data		Approvals / Standards	
Current	16 A	Reference standard	EN 60309-1, -2 e -4
Voltage	100 ÷ 130 V	General ordering information	
IP degree of protection	IP67	EAN13 code	8015747004367
Further technical details		Packaging Information	
Weight	1.300,00 g	Sub-packaging length	116,00 mm
Operating temperature range (min, max)	-25°C ... +40°C	Sub-packaging height	130,00 mm
IK rating (impact degree of protection)	IK10	Sub-packaging width	230,00 mm
		Sub-packaging weight	1,30 kg
		Sub-packaging volume	3,47 dm ³
		Sub-packaging description	Carton box
		Sub-packaging quantity	1 Pcs
		Sub-packaging EAN barcode	8015747004381

Part number

BK 1644



Catalogue drawings

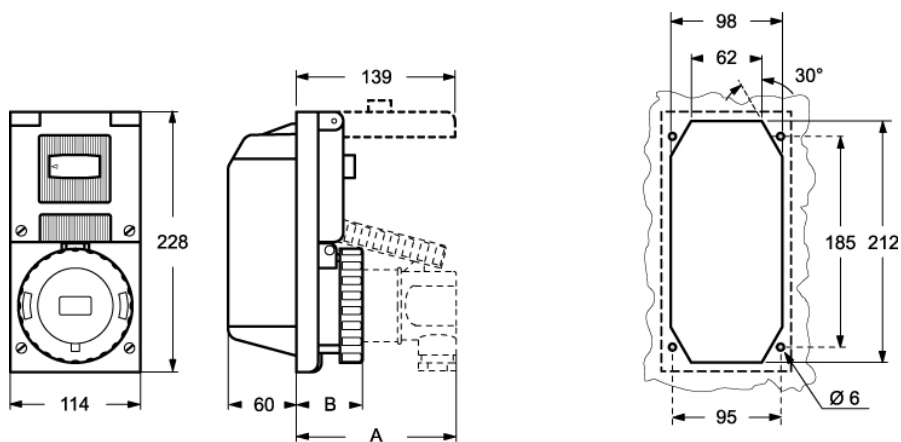

BK		A	B
16A	2P + ⊕	105	50
	3P + ⊕	105	50
	3P + N + ⊕	110	50
32A	2P + ⊕	140	58
	3P + ⊕	140	58
	3P + N + ⊕	140	58