

Part number

AS C16P



Complete cable gland, Pg16, for diameter
9,5-14 mm

Product description

Product type	Complete cable gland
Cable entry	Pg16
Specification	For diameter 9,5-14 mm

Technical data

IP degree of protection	IP68
--------------------------------	------

Further technical details

Weight	39,00 g
Operating temperature range (min, max)	-25°C ... +120°C

General ordering information

EAN13 code	8015747131957
-------------------	---------------

Packaging Information

Sub-packaging weight	0,39 kg
Sub-packaging description	Plastic bag
Sub-packaging quantity	10 Pcs
Sub-packaging EAN barcode	8015747133654

Part number

AS C16P



Catalogue drawings

AS C..P - AS M..P

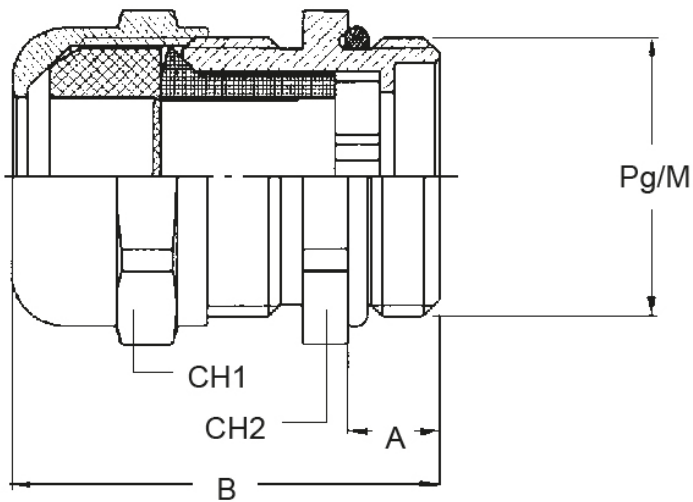

AS C..P	A	B	CH1	CH2
11	6	26	20	20
13,5	6,5	28	22	22
16	6,5	30	24	24
21	7	35	30	30
29	8	43	40	40
36	9	50	50	50
42	10	57	58	58

AS M..P	A	B	CH1	CH2
20	7	29	22	22
25	8	37	30	30
32	8,5	45	40	40
40	8,5	45	40	42
50	9,5	51	50	55
