

Part number

TM 3224KSIR



Interlocked switched socket-outlet, TM series, 3 poles + PE, 2 h (green), 32 A, > 50 V, with compartment for modular units, 4,5 DIN-rail modules EN 60715, without base box

Product description

Product type	Interlocked switched socket-outlet
Series	TM..SIR/KSIR
N. of poles	3 poles + 
Clock position	2
Specification	With compartment for modular units, 4,5 DIN-rail modules EN 60715 Without base box

Technical data

Current	32 A
Voltage	> 50 V
IP degree of protection	IP66 / IP67

Further technical details

Operating temperature range (min, max)	-25°C ... +40°C
UL 94 flammability rating	V-2
IK rating (impact degree of protection)	IK10

Material properties

Colour	RAL 7012 grey, RAL 6017 green
---------------	-------------------------------

Approvals / Standards

Reference standard	EN 60309-1, -2 e -4
---------------------------	---------------------

General ordering information

EAN13 code	8015747162456
-------------------	---------------

Part number

TM 3224KSIR



Catalogue drawings

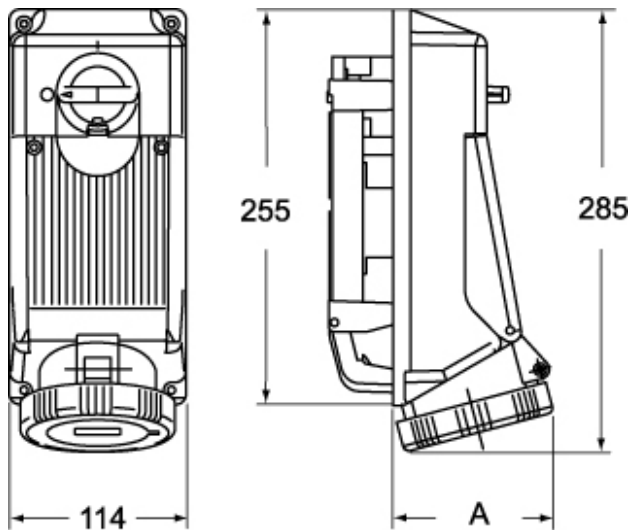

	A
2P+⊕	96
3P+⊕	96
3P+N+⊕	101