

Part number

SIM1D 0.5C



Male crimp contact, SI series, 5 A, stamped gold plated, wire cross section 0,21 - 0,52 mm², AWG 24 - 20, coil packaging, for 500 mating cycles

Product description

Product type	Crimp contact
Series	SI
Gender	Male
Specification	Coil packaging For 500 mating cycles

Technical data

Current	5 A
Wire cross-section	0,21 mm ² - 0,52 mm ²
AWG size	24 - 20
Contact type	Stamped gold plated

Further technical details

Contact resistance	≤ 10 mΩ
Weight	0,22 g
Conductors stripping length	3 mm

Material properties

RoHS conformity	Compliant
China RoHS - EFUP	E
REACH SVHC substances	No

Approvals / Standards

Certifications	EAC
UL	ECBT2
cUL	ECBT8

General ordering information

EAN13 code	8015747277075
eCl@ss 8.1	27440204
ETIM 7.0	EC000796

Packaging Information

Packaging weight	0,13 kg
Packaging description	Plastic bag
Packaging quantity	500 Pcs
Packaging EAN code	8015747189620

Part number

SIM1D 0.5C



Catalogue drawings

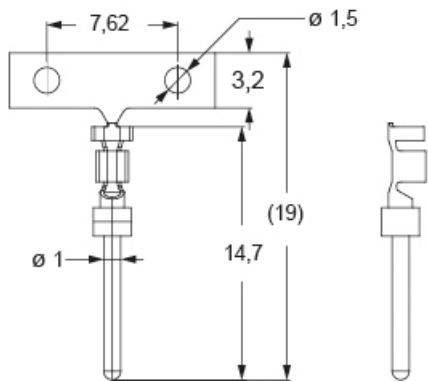

SIM..D C

