

Part number

PK 6393 PB5



Interlocked switched socket-outlet, PK series,
2 poles + PE, 9 h (red), 63 A, 380 ÷ 415 V,
E33 - DIII fuse carrier

Product description		Material properties	
Product type	Interlocked switched socket-outlet	Colour	RAL 7035 grey, RAL 3000 red
Series	PK..PB5		Compliant with exemption 6(c): copper alloy containing up to 4% lead by weight
N. of poles	2 poles +	RoHs conformity	6(c): copper alloy containing up to 4% lead by weight
Clock position	9	China RoHs - EFUP	50
Specification	E33 - DIII fuse carrier	REACH SVHC substances	Yes Lead
Technical data		SCIP number	F6799547-ab84-42f2-938f-233ba663766d
Current	63 A	Approvals / Standards	
Voltage	380 ÷ 415 V	Reference standard	EN 60309-1, -2 e -4
IP degree of protection	IP55	General ordering information	
Further technical details		EAN13 code	8015747082921
Weight	3.400,00 g	Packaging Information	
Operating temperature range (min, max)	-25°C ... +40°C	Packaging length	400,00 mm
IK rating (impact degree of protection)	IK10	Packaging height	165,00 mm
		Packaging width	170,00 mm
		Packaging weight	4,00 kg
		Packaging volume	11,22 dm ³
		Packaging description	Carton box
		Packaging quantity	1 Pcs
		Packaging EAN code	8015747082938

Part number

PK 6393 PB5



Catalogue drawings

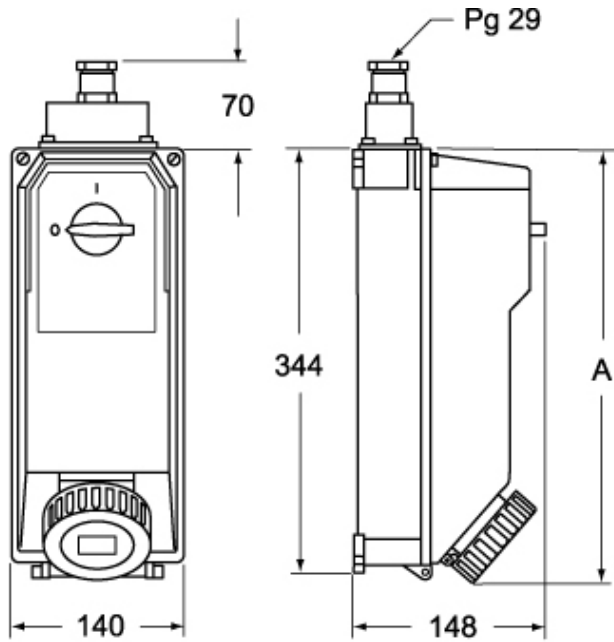

	A
2P+⊕	360
3P+⊕	360
3P+N+⊕	382