

Part number

PK 6343 PB5



Interlocked switched socket-outlet, PK series,
2 poles + PE, 4 h (yellow), 63 A, 100 ÷ 130 V,
E33 - DIII fuse carrier

Product description

Product type	Interlocked switched socket-outlet
Series	PK..PB5
N. of poles	2 poles + 
Clock position	4
Specification	E33 - DIII fuse carrier

Technical data

Current	63 A
Voltage	100 ÷ 130 V
IP degree of protection	IP55

Further technical details

Weight	3.400,00 g
Operating temperature range (min, max)	-25°C ... +40°C
IK rating (impact degree of protection)	IK10

Material properties

Colour	RAL 7035 grey, RAL 1021 yellow
RoHs conformity	Compliant with exemption 6(c): copper alloy containing up to 4% lead by weight
China RoHs - EFUP	50
REACH SVHC substances	Yes Lead
SCIP number	F6799547-ab84-42f2-938f-233ba663766d

Approvals / Standards

Reference standard	EN 60309-1, -2 e -4
---------------------------	---------------------

General ordering information

EAN13 code	8015747082235
-------------------	---------------

Packaging Information

Packaging length	400,00 mm
Packaging height	165,00 mm
Packaging width	170,00 mm
Packaging weight	4,00 kg
Packaging volume	11,22 dm ³
Packaging description	Carton box
Packaging quantity	1 Pcs
Packaging EAN code	8015747082242

Part number

PK 6343 PB5



Catalogue drawings

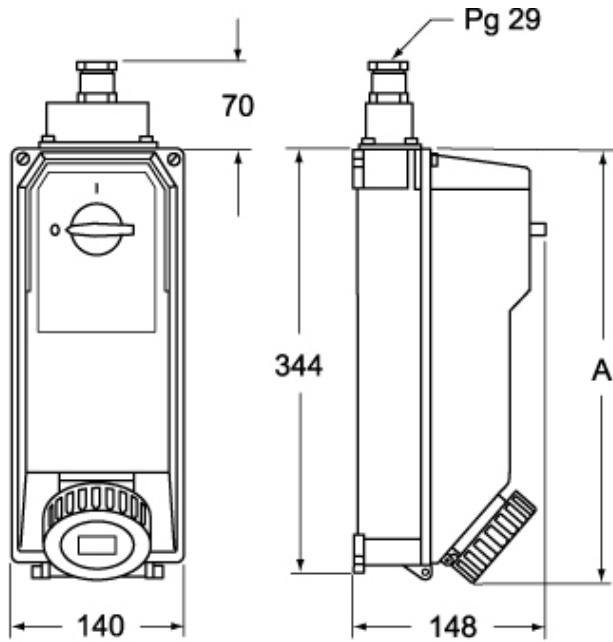

	A
2P+⊕	360
3P+⊕	360
3P+N+⊕	382