

Part number

PK 1643 PB5



Interlocked switched socket-outlet, PK series,
2 poles + PE, 4 h (yellow), 16 A, 100 ÷ 130 V,
E16 fuse carrier

Product description		Material properties	
Product type	Interlocked switched socket-outlet	Colour	RAL 7035 grey, RAL 1021 yellow
Series	PK..PB5		Compliant with exemption 6(c): copper alloy containing up to 4% lead by weight
N. of poles	2 poles +	RoHs conformity	6(c): copper alloy containing up to 4% lead by weight
Clock position	4	China RoHs - EFUP	50
Specification	E16 fuse carrier	REACH SVHC substances	Yes Lead
Technical data		SCIP number	Ce861c8d-b979-403b-96d9-80aef6dc281d
Current	16 A	Approvals / Standards	
Voltage	100 ÷ 130 V	Reference standard	EN 60309-1, -2 e -4
IP degree of protection	IP55	General ordering information	
Further technical details		EAN13 code	8015747080019
Weight	1.600,00 g	Packaging Information	
Operating temperature range (min, max)	-25°C ... +40°C	Sub-packaging length	285,00 mm
IK rating (impact degree of protection)	IK10	Sub-packaging height	130,00 mm
		Sub-packaging width	130,00 mm
		Sub-packaging weight	1,60 kg
		Sub-packaging volume	4,82 dm ³
		Sub-packaging description	Carton box
		Sub-packaging quantity	1 Pcs
		Sub-packaging EAN barcode	8015747080026

Part number

PK 1643 PB5



Catalogue drawings

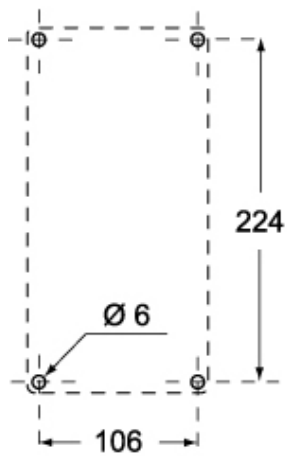
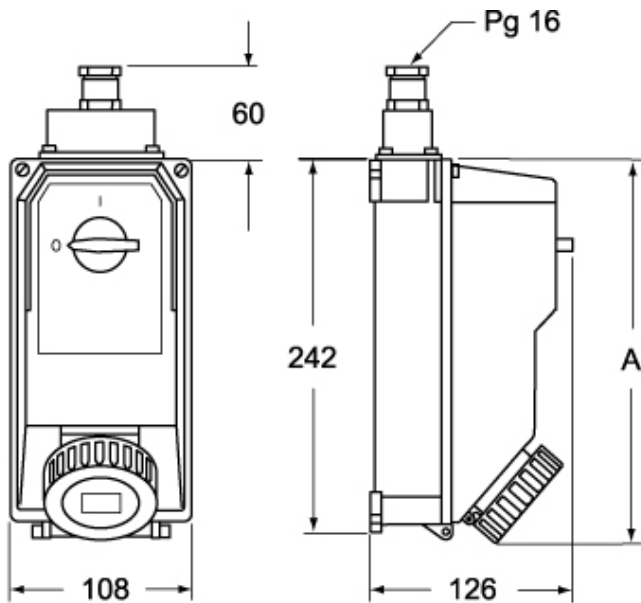

	A
2P+⊕	260
3P+⊕	260
3P+N+⊕	270