

Part number

# PE 1643 PIF



Flush-mounting socket outlet, PLUSO series, 2 poles + PE, 4 h (yellow), 16 A, 100 ÷ 130 V, inclined, with bigger flange

Product description		Material properties	
<b>Product type</b>	Socket Flush-mounting	<b>Colour</b>	RAL 7035 grey, RAL 1021 yellow
<b>Series</b>	PE...PIF, PLUSO	<b>RoHs conformity</b>	Compliant with exemption 6(c): copper alloy containing up to 4% lead by weight
<b>N. of poles</b>	2 poles + 	<b>China RoHs - EFUP</b>	50
<b>Clock position</b>	4	<b>REACH SVHC substances</b>	Yes Lead
<b>Size</b>	Socket fixing centre distance 77 x 85 mm	<b>SCIP number</b>	Ca7de37f-add8-4b77-9861-279c94903ade
<b>Specification</b>	Inclined, bigger flange	<b>Approvals / Standards</b>	
<b>Technical data</b>		<b>Reference standard</b>	EN 60309-1 and -2
<b>Current</b>	16 A	<b>General ordering information</b>	
<b>Voltage</b>	100 ÷ 130 V	<b>EAN13 code</b>	8015747063739
<b>IP degree of protection</b>	IP44	<b>Packaging Information</b>	
<b>Further technical details</b>		<b>Packaging length</b>	285,00 mm
<b>Weight</b>	133,00 g	<b>Packaging height</b>	170,00 mm
<b>Operating temperature range (min, max)</b>	-25°C ... +40°C	<b>Packaging width</b>	190,00 mm
		<b>Packaging weight</b>	1,54 kg
		<b>Packaging volume</b>	9,21 dm <sup>3</sup>
		<b>Packaging description</b>	Carton box
		<b>Packaging quantity</b>	10 Pcs
		<b>Packaging EAN code</b>	8015747063746

Part number

# PE 1643 PIF



Catalogue drawings

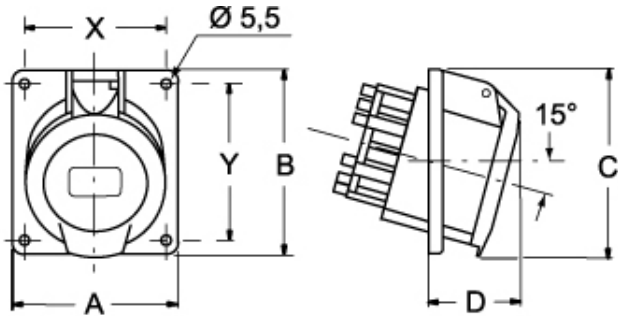

			A	B	C	D	X	Y
<b>PIF</b>	<b>16 A</b>	2P+⊕	92	100	--	52	77	85
		3P+⊕	92	100	--	53	77	85
<b>PI</b>	<b>16 A</b>	2P+⊕	64	82	--	38	52	60
		3P+⊕	64	82	--	42	52	60
		3P+N+⊕	92	100	--	43	77	60
<b>PI</b>	<b>32 A</b>	2P+⊕	92	100	--	40	77	85
		3P+⊕	92	100	--	40	77	85
		3P+N+⊕	92	102	--	43	77	85