

Part number

MMFV 03 LG25



Hood, 830V series, with 1 lever, M25 top cable entry without adapter, size "57.27", high construction

Product description

Product type	Hood
Series	830V
Closing type	With 1 lever
Size	Size 57.27
Cable entry	Top cable entry M25
Specification	High construction

Technical data

IP degree of protection	IP65 / IP66 / IP69
--------------------------------	--------------------

Further technical details

Operating temperature range (min, max)	-40°C...+125°C
---	----------------

Material properties

Colour	RAL 7040 grey
RoHs conformity	Compliant
China RoHs - EFUP	E
REACH SVHC substances	No

Approvals / Standards

Certifications	DNV, BV
UL	ECBT2
cUL	ECBT8

General ordering information

EAN13 code	8015747152938
-------------------	---------------

Part number

MMFV 03 LG25



Catalogue drawings

CMO L (CMAO L) - MMO L [MMAO L]
CMV L [CMAV L] - MMV L (MMAV L)

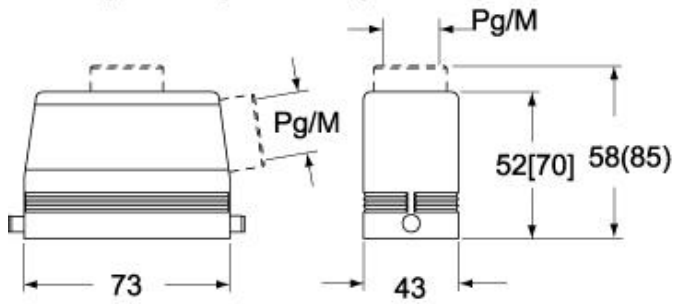

CMV LG (CMAV LG) - MMV LG (MMAV LG)
[MMFV LG]

