

Part number

MAV 50 X32



Hood, C-TYPE series, with 2 levers, M32 top cable entry, size "66.40", high construction, without gasket

Product description		Material properties	
Product type	Hood	Other materials	Lever: Stainless steel, polyamide (PA)
Series	C-TYPE	Colour	RAL 7040 grey
Closing type	With 2 levers		Compliant with exemption 6(c): copper alloy containing up to 4% lead by weight
Size	Size "66.40"	RoHs conformity	50
Cable entry	Top cable entry with adapter M32	China RoHs - EFUP	Yes
Specification	High construction, without gasket	REACH SVHC substances	Lead
Technical data		SCIP number	15deaf78-e939-4401-a0b0-e2228ca32a03
IP degree of protection	IP65 / IP66 / IP69	Approvals / Standards	
Further technical details		Certifications	DNV, BV
Weight	360,00 g	UL	ECBT2
Operating temperature range (min, max)	-40°C...+125°C	cUL	ECBT8
		General ordering information	
		EAN13 code	8015747052924
		eCl@ss 8.1	27440202
		ETIM 7.0	EC000437
		Packaging Information	
		Packaging length	240,00 mm
		Packaging height	120,00 mm
		Packaging width	355,00 mm
		Packaging weight	3,70 kg
		Packaging volume	10,22 dm ³
		Packaging description	Carton box
		Packaging quantity	10 Pcs
		Packaging EAN code	8015747098861

Part number

MAV 50 X32



Catalogue drawings

CHO X (CAO X) - CAV X
MHO X (MAO X/MFO X/MFV X) - MAV X

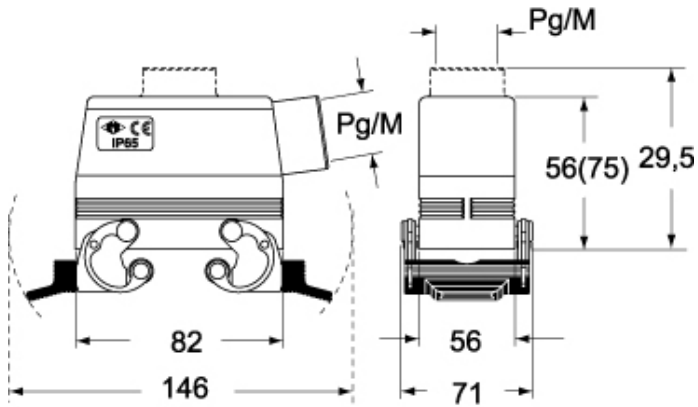

CHC



CHC G

