

Part number

MAP 24 CS40

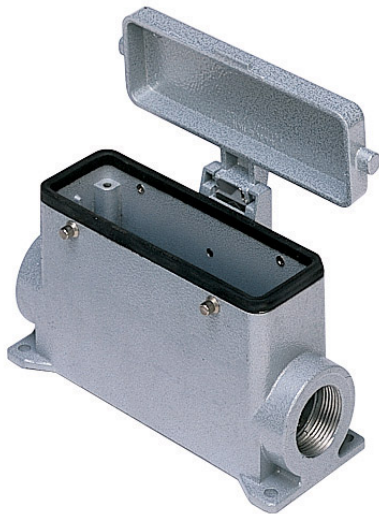

Surface mounting housing, C-TYPE series, with 4 pegs, M40 cable entry, size "104.27", high construction, with metal cover

Product description

Product type	Surface mounting housing
Series	C-TYPE
Closing type	With 4 pegs
Size	Size 104.27
Cable entry	With cable entry M40
Specification	High construction, with metal cover

Technical data

IP degree of protection	IP65
--------------------------------	------

Further technical details

Weight	438,00 g
Operating temperature range (min, max)	-40°C...+125°C

Material properties

Other materials	Gasket: NBR
Colour	RAL 7040 grey
RoHs conformity	Compliant
China RoHs - EFUP	E
REACH SVHC substances	No

Approvals / Standards

Certifications	DNV, BV
UL	ECBT2
cUL	ECBT8

General ordering information

EAN13 code	8015747051804
eCl@ss 8.1	27440202
ETIM 7.0	EC000437

Packaging Information

Packaging length	475,00 mm
Packaging height	220,00 mm
Packaging width	200,00 mm
Packaging weight	4,40 kg
Packaging volume	20,90 dm ³
Packaging description	Carton box
Packaging quantity	10 Pcs
Packaging EAN code	8015747245036
Sub-packaging weight	2,20 kg
Sub-packaging description	Plastic packaging
Sub-packaging quantity	5 Pcs
Sub-packaging EAN barcode	8015747245043

Part number

MAP 24 CS40



Catalogue drawings

CHP CAP - MHP MAP

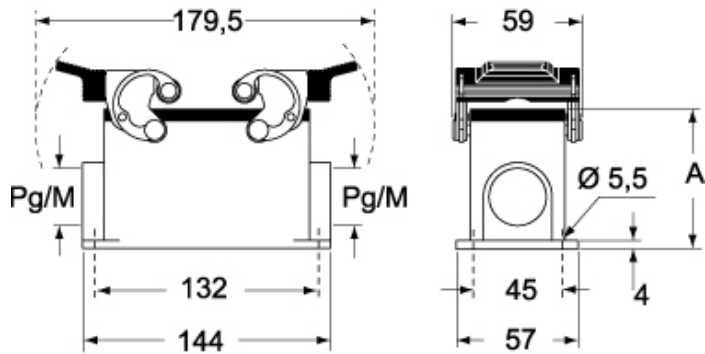

CHP CS/CP CAP CS/CP - MHP CS/CP MAP CS/CP

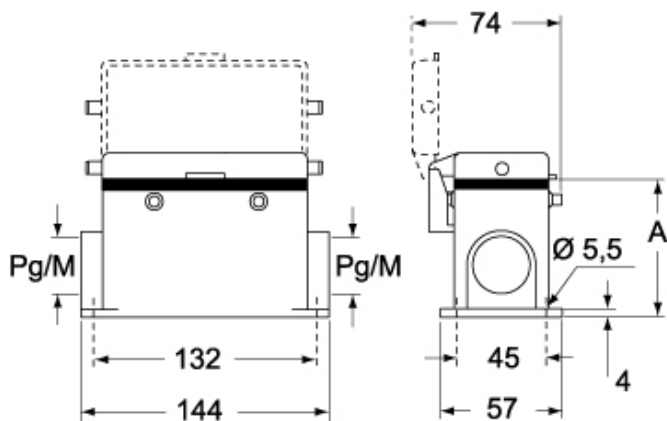

	A
CHP / MHP	63
CAP / MAP	80
CHP CS / MHP CS	63
CAP CS / MAP CS	80
CHP CP / MHP CP	63
CAP CP / MAP CP	80