

Part number

# MAP 10.32



Surface mounting housing, C-TYPE series, with 2 levers, M32 cable entry, size "57.27", high construction



#### Product description

<b>Product type</b>	Surface mounting housing
<b>Series</b>	C-TYPE
<b>Closing type</b>	With 2 levers
<b>Size</b>	Size 57.27
<b>Cable entry</b>	With cable entry M32
<b>Specification</b>	High construction

#### Technical data

<b>IP degree of protection</b>	IP65 / IP66 / IP69
--------------------------------	--------------------

#### Further technical details

<b>Weight</b>	380,00 g
<b>Operating temperature range (min, max)</b>	-40°C...+125°C

#### Material properties

<b>Other materials</b>	Lever: Stainless steel, polyamide (PA) Gasket: NBR
<b>Colour</b>	RAL 7040 grey
<b>RoHs conformity</b>	Compliant
<b>China RoHs - EFUP</b>	E
<b>REACH SVHC substances</b>	No

#### Approvals / Standards

<b>Certifications</b>	DNV, BV
<b>UL</b>	ECBT2
<b>cUL</b>	ECBT8

#### General ordering information

<b>EAN13 code</b>	8015747051323
<b>eCl@ss 8.1</b>	27440202
<b>ETIM 7.0</b>	EC000437

#### Packaging Information

<b>Packaging length</b>	475,00 mm
<b>Packaging height</b>	200,00 mm
<b>Packaging width</b>	150,00 mm
<b>Packaging weight</b>	3,80 kg
<b>Packaging volume</b>	14,25 dm <sup>3</sup>
<b>Packaging description</b>	Carton box
<b>Packaging quantity</b>	10 Pcs
<b>Packaging EAN code</b>	8015747244596
<b>Sub-packaging weight</b>	1,90 kg
<b>Sub-packaging description</b>	Plastic packaging
<b>Sub-packaging quantity</b>	5 Pcs
<b>Sub-packaging EAN barcode</b>	8015747051330

Part number

# MAP 10.32



Catalogue drawings

## CHP CAP - MHP MAP

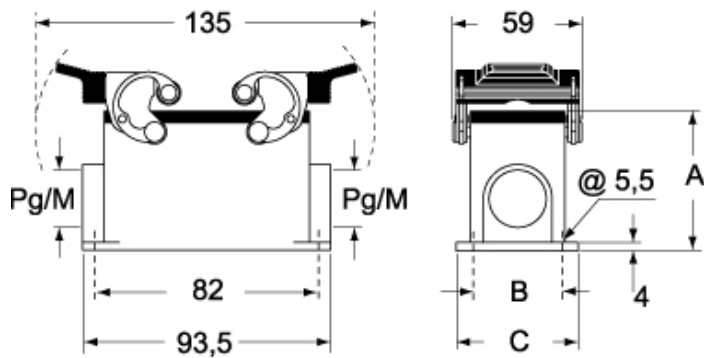

## CHP CS/CP CAP CS/CP - MHP CS/CP MAP CS/CP



	A	B	C
CHP L / MHP L	57	40	52
CAP L / MAP L	73	45	57
CHP CS / MHP CS	57	40	52
CAP CS / MAP CS	73	45	57
CHP CP / MHP CP	57	40	52
CAP CP / MAP CP	73	45	57