

Part number

M7AP 06LS232



Surface mounting housing, V-TYPE series, with 1 lever, M32 x 2 cable entry, size "44.27", high construction, with metal cover

Product description	
Product type	Surface mounting housing
Series	V-TYPE
Closing type	With 1 lever
Size	Size 44.27
Cable entry	With cable entry M32 x 2
Specification	High construction, with metal cover
Technical data	
IP degree of protection	IP66 / IP67 / IP69
Further technical details	
Operating temperature range (min, max)	-40°C...+125°C

Material properties	
Other materials	Lever: Stainless steel Gasket: NBR
Colour	RAL 7040 grey
RoHs conformity	Compliant
China RoHs - EFUP	E
REACH SVHC substances	No
Approvals / Standards	
Certifications	DNV, BV
UL	ECBT2
cUL	ECBT8
General ordering information	
EAN13 code	8015747240093
eCl@ss 8.1	27440202
ETIM 7.0	EC000437

Part number

M7AP 06LS232



Catalogue drawings

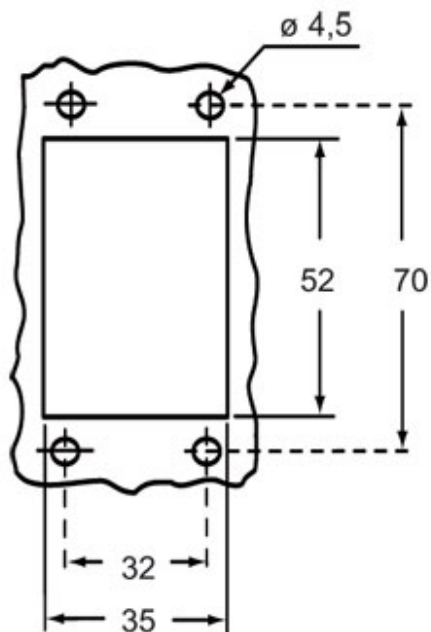

Catalogue drawings

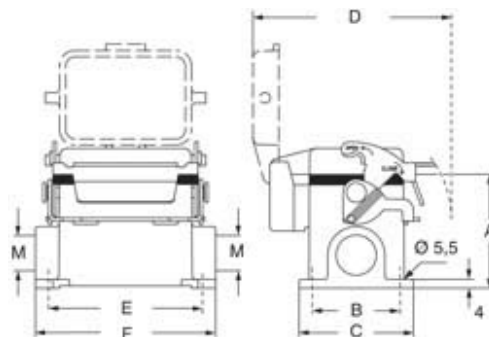

type	A	B	C	D	E	F
M7P 06 LS	53	40	52	91	70	82
M7AP 06 LS	73	45	57	91	70	82