

Part number

JCVP 16 LP



Surface mounting housing, JEI®-V series, with 1 lever, Pg21 cable entry, size "77.27", with plastic cover

Product description		Material properties	
Product type	Surface mounting housing	Other materials	Lever: Galvanized steel Gasket: NBR
Series	JEI®-V	Colour	RAL 7040 grey
Closing type	With 1 lever	Approvals / Standards	
Size	Size 77.27	Certifications	DNV, BV
Cable entry	With cable entry Pg21	UL	ECBT2
Specification	With plastic cover	cUL	ECBT8
Technical data		General ordering information	
IP degree of protection	IP65	EAN13 code	8015747137751
Further technical details		Packaging Information	
Weight	320,00 g	Packaging length	210,00 mm
Operating temperature range (min, max)	-40°C...+125°C	Packaging height	155,00 mm
		Packaging width	350,00 mm
		Packaging weight	3,30 kg
		Packaging volume	11,39 dm ³
		Packaging description	Carton box
		Packaging quantity	10 Pcs
		Packaging EAN code	8015747144131
		Sub-packaging weight	1,65 kg
		Sub-packaging description	Plastic packaging
		Sub-packaging quantity	5 Pcs
		Sub-packaging EAN barcode	8015747140430

Part number

JCVP 16 LP



Catalogue drawings

JCVP LP

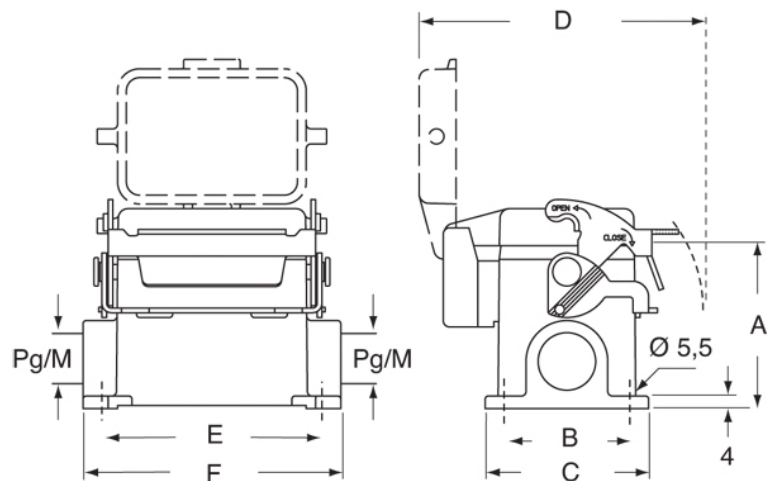

	A	B	C	D	E	F
JCVP 06 LP	53	40	52	91	70	82
JCVP 10 LP	57	40	52	94	82	93,5
JCVP 16 LP	63	45	57	94	105	117
JCVP 24 LP	63	45	57	94	132	144