

Part number

FM 4272 PI



Box system for socket-outlet combinations, FM series, for inclined flush-mounting sockets, 8 openings

Product description

Product type	Box system for socket-outlet combinations
Series	FM
Size	420 x 720 x 135 mm
Specification	For inclined flush-mounting sockets 8 openings

Technical data

IP degree of protection	IP55
Further technical details	
Weight	4.000,00 g
Operating temperature range (min, max)	-40°C ... +125°C

Material properties

Colour	RAL 7035 grey
---------------	---------------

General ordering information

EAN13 code	8015747047760
-------------------	---------------

Packaging Information

Packaging length	430,00 mm
Packaging height	150,00 mm
Packaging width	730,00 mm
Packaging weight	4,80 kg
Packaging volume	47,09 dm ³
Packaging description	Carton box
Packaging quantity	1 Pcs
Packaging EAN code	8015747047777

Part number

FM 4272 PI



Catalogue drawings

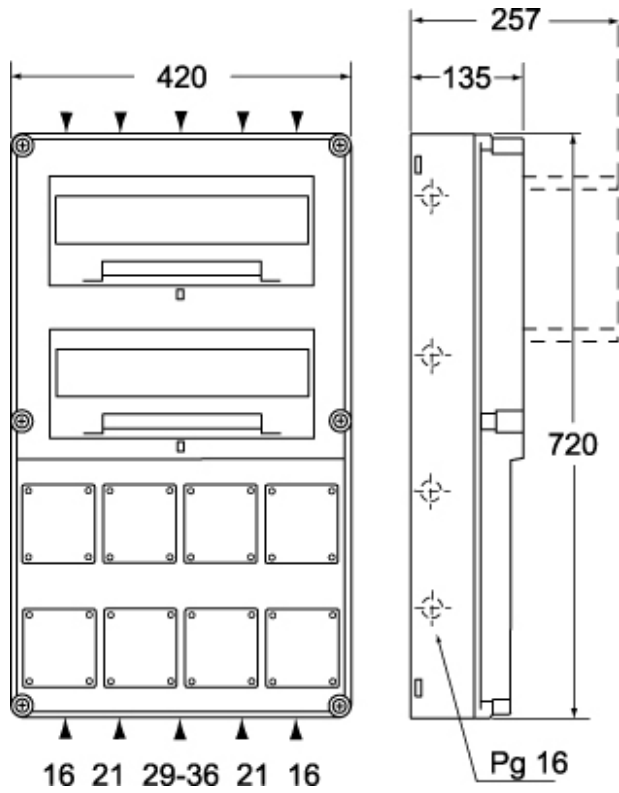

Catalogue drawings

