

Part number

FC 1453 TB



Modular back plate for socket outlets set mounting, FC series

Product description

Product type	Modular back plate for socket outlets set mounting
Series	FC
Size	143x343 fixing plates FC xx53 TB

Further technical details

Weight	436,00 g
Operating temperature range (min, max)	-40°C ... +125°C

Material properties

Colour	RAL 7035 grey
---------------	---------------

General ordering information

EAN13 code	8015747045544
-------------------	---------------

Packaging Information

Packaging length	310,00 mm
Packaging height	170,00 mm
Packaging width	550,00 mm
Packaging weight	5,40 kg
Packaging volume	28,99 dm ³
Packaging description	Carton box
Packaging quantity	10 Pcs
Packaging EAN code	8015747045551

Part number

FC 1453 TB



Catalogue drawings

FC 1141 TB

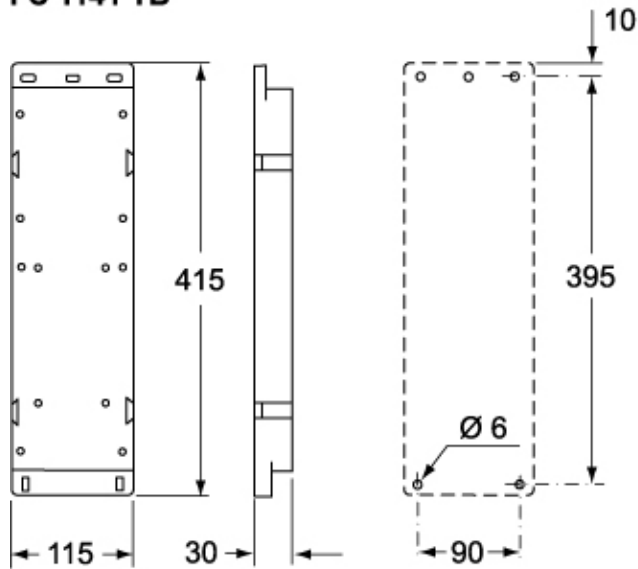

FC 1453 TB

