

Part number

CSHM 10



Male insert, CSH series, SQUICH® spring terminal connection without tools, 10 poles + PE, 16 A 500 V 6 kV 3, size "57.27"

Product description		Material properties	
Product type	Insert	Main material	Polycarbonate (PC)
Series	CSH	Other materials	Contacts: copper alloy
Connection type	SQUICH® spring terminal connection without tools	Colour	RAL 7032 grey
Gender	Male	RoHs conformity	Compliant with exemption 6(c): copper alloy containing up to 4% lead by weight
N. of poles	10 poles + 	China RoHs - EFUP	50
Size	Size 57.27	REACH SVHC substances	Yes Lead
Technical data		SCIP number	1a9c93ff-0445-4a16-81e3-1609ac5274d6
Current	16 A	Approvals / Standards	
Voltage	500 V	Reference standard	EN 61984:2009-06
Rated impulse withstand voltage	6 kV	Certifications	CSA, CQC, DNV, BV, EAC
Pollution degree	3	UL	ECBT2, PVVA2
Rated voltage according to UL/CSA	600 V	cUL	ECBT8, PVVA8
Wire cross-section	0,14 mm ² - 2,50 mm ²	General ordering information	
AWG size	26 - 14	EAN13 code	8015747054003
Contact type	Turned silver plated	eCl@ss 8.1	27440205
IP degree of protection	IP20 without enclosure, IP65/IP66/IP68/IP69 with enclosure	ETIM 7.0	EC000438
Further technical details		Packaging Information	
Characteristics according to EN 61984	16A 500V 6kV 3; 16A 400/690V 6kV 2	Packaging length	245,00 mm
Mating cycles	≥ 500	Packaging height	165,00 mm
Insulation resistance	≥ 10 GΩ	Packaging width	215,00 mm
Contact resistance	≤ 3 mΩ	Packaging weight	2,35 kg
Weight	63,50 g	Packaging volume	8,69 dm ³
Operating temperature range (min, max)	-40 °C ... +125 °C	Packaging description	Carton box
Conductors stripping length	9...11 mm	Packaging quantity	30 Pcs
UL 94 flammability rating	V-0	Packaging EAN code	8015747170741
		Sub-packaging length	197,00 mm
		Sub-packaging height	44,00 mm
		Sub-packaging width	113,00 mm
		Sub-packaging weight	0,39 kg
		Sub-packaging volume	0,98 dm ³
		Sub-packaging description	Carton tray
		Sub-packaging quantity	5 Pcs
		Sub-packaging EAN barcode	8015747170758

Part number

CSHM 10



Catalogue drawings

Catalogue drawings

dimensions in mm

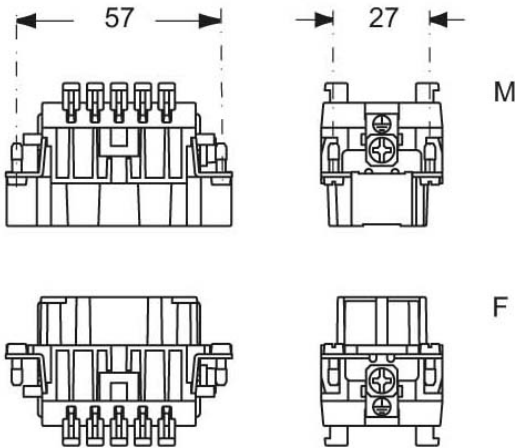

contacts side (front view)

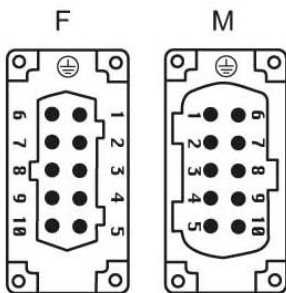

diagram CSH 10 poles

