

Part number

CRZ 06



Reduction plate, size "104.27", with gasket, for bulkhead mounting housings size "44.27"

Product description

Product type	Reduction plate
Size	Size 104.27
Specification	With gasket For bulkhead mounting housings size "44.27"

Further technical details

Weight	40,00 g
---------------	---------

General ordering information

EAN13 code	8015747039666
eCl@ss 8.1	27440201
ETIM 7.0	EC002309

Packaging Information

Packaging length	160,00 mm
Packaging height	128,00 mm
Packaging width	350,00 mm
Packaging weight	2,27 kg
Packaging volume	7,17 dm ³
Packaging description	Carton box
Packaging quantity	50 Pcs
Packaging EAN code	8015747039673
Sub-packaging weight	0,23 kg
Sub-packaging description	Plastic packaging
Sub-packaging quantity	5 Pcs
Sub-packaging EAN barcode	8015747039680

Part number

CRZ 06



Catalogue drawings

CRH

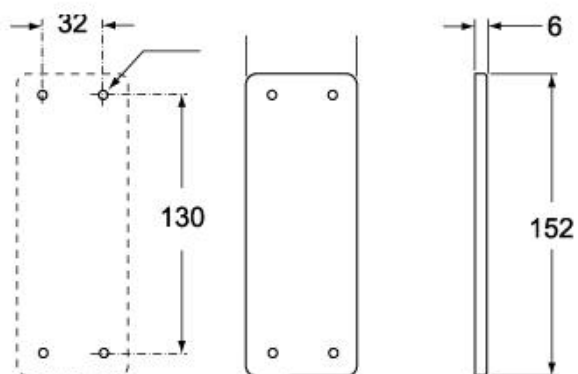

CRZ

