

Part number

# CHV 32 G42



Hood, C-TYPE series, with 2 levers, Pg42 top cable entry, size "77.62"

#### Product description

<b>Product type</b>	Hood
<b>Series</b>	C-TYPE
<b>Closing type</b>	With 2 levers
<b>Size</b>	Size 77.62
<b>Cable entry</b>	Top cable entry with adapter Pg42

#### Technical data

**IP degree of protection** IP65 / IP66 / IP69

#### Further technical details

<b>Weight</b>	561,78 g
<b>Operating temperature range (min, max)</b>	-40°C...+125°C

#### Material properties

<b>Other materials</b>	Lever: Stainless steel, polyamide (PA) Gasket: NBR
<b>Colour</b>	RAL 7040 grey
<b>RoHs conformity</b>	Compliant with exemption 6(c): copper alloy containing up to 4% lead by weight
<b>China RoHs - EFUP</b>	50
<b>REACH SVHC substances</b>	Yes Lead
<b>SCIP number</b>	15deaf78-e939-4401-a0b0-e2228ca32a03
<b>Approvals / Standards</b>	
<b>Certifications</b>	DNV, BV
<b>UL</b>	ECBT2
<b>cUL</b>	ECBT8

#### General ordering information

**EAN13 code** 8015747024952

#### Packaging Information

<b>Sub-packaging weight</b>	0,56 kg
<b>Sub-packaging description</b>	Plastic packaging
<b>Sub-packaging quantity</b>	1 Pcs
<b>Sub-packaging EAN barcode</b>	8015747024969

Part number

# CHV 32 G42



Catalogue drawings

**CHO - CHV MHO/MFO/MFV - MHV  
MMV (MMAV)**

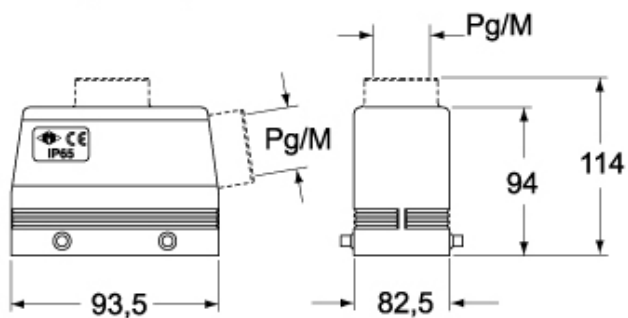

**CHV G - MHV G - MFV G**

