

Part number

CHP 50.29



Surface mounting housing, C-TYPE series, with 2 levers, Pg29 cable entry, size "66.40"



Product description

Product type	Surface mounting housing
Series	C-TYPE
Closing type	With 2 levers
Size	Size "66.40"
Cable entry	With cable entry Pg29

Technical data

IP degree of protection IP65 / IP66 / IP69

Further technical details

Weight	456,00 g
Operating temperature range (min, max)	-40°C...+125°C

Material properties

Other materials	Lever: Stainless steel, polyamide (PA) Gasket: NBR
Colour	RAL 7040 grey
RoHs conformity	Compliant
China RoHs - EFUP	E
REACH SVHC substances	No

Approvals / Standards

Certifications	DNV, BV
UL	ECBT2
cUL	ECBT8

General ordering information

EAN13 code 8015747023306

Packaging Information

Packaging length	350,00 mm
Packaging height	105,00 mm
Packaging width	145,00 mm
Packaging weight	2,44 kg
Packaging volume	5,33 dm ³
Packaging description	Carton box
Packaging quantity	5 Pcs
Packaging EAN code	8015747023313

Part number

CHP 50.29



Catalogue drawings

CHP - MHP



CHP CS - MHP CS

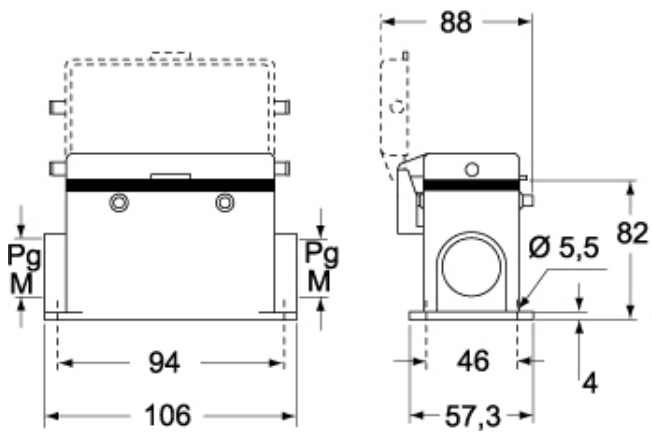

Catalogue drawings

