

Part number

# CHP 24 LS



Surface mounting housing, C-TYPE series, with 1 lever, Pg21 cable entry, size "104.27", with metal cover

Product description		Material properties	
<b>Product type</b>	Surface mounting housing	<b>Other materials</b>	Lever: Stainless steel, polyamide (PA) Gasket: NBR
<b>Series</b>	C-TYPE	<b>Colour</b>	RAL 7040 grey
<b>Closing type</b>	With 1 lever	<b>RoHs conformity</b>	Compliant
<b>Size</b>	Size 104.27	<b>China RoHs - EFUP</b>	E
<b>Cable entry</b>	With cable entry Pg21	<b>REACH SVHC substances</b>	No
<b>Specification</b>	With metal cover	<b>Approvals / Standards</b>	
<b>Technical data</b>		<b>Certifications</b>	DNV, BV
<b>IP degree of protection</b>	IP65	<b>UL</b>	ECBT2
<b>Further technical details</b>		<b>cUL</b>	ECBT8
<b>Weight</b>	440,00 g	<b>General ordering information</b>	
<b>Operating temperature range (min, max)</b>	-40°C...+125°C	<b>EAN13 code</b>	8015747022590
		<b>Packaging Information</b>	
		<b>Packaging length</b>	475,00 mm
		<b>Packaging height</b>	180,00 mm
		<b>Packaging width</b>	200,00 mm
		<b>Packaging weight</b>	4,59 kg
		<b>Packaging volume</b>	17,10 dm <sup>3</sup>
		<b>Packaging description</b>	Carton box
		<b>Packaging quantity</b>	10 Pcs
		<b>Packaging EAN code</b>	8015747022606
		<b>Sub-packaging weight</b>	2,30 kg
		<b>Sub-packaging description</b>	Plastic packaging
		<b>Sub-packaging quantity</b>	5 Pcs
		<b>Sub-packaging EAN barcode</b>	8015747022613

Part number

# CHP 24 LS



Catalogue drawings

## CHP L CAP L - MHP L MAP L

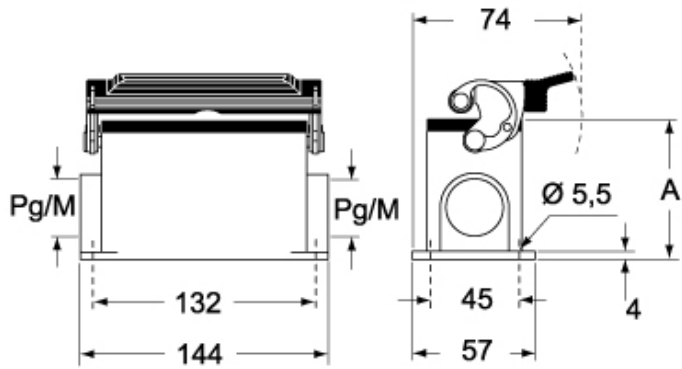

## CHP LS CAP LS - MHP LS MAP LS



	<b>A</b>
<b>CHP L / MHP L</b>	63
<b>CAP L / MAP L</b>	80
<b>CHP LS / MHP LS</b>	63
<b>CAP LS / MAP LS</b>	80