

Part number

CGC 16 G



Cover, IP68 series, with 2 screws, size "77.27",
for hoods

Product description		Material properties	
Product type	Cover	Main material	Aluminium die-cast
Series	IP68	Other materials	Screws: Stainless steel
Closing type	With 2 screws	Colour	RAL 9005 black
Size	Size 77.27	RoHs conformity	Compliant
Cable entry	For hoods	China RoHs - EFUP	E
Technical data		REACH SVHC substances	No
IP degree of protection	IP66 / IP68 / IP69	General ordering information	
Further technical details		EAN13 code	8015747292665
Weight	157,31 g	eCl@ss 8.1	27440208
Operating temperature range (min, max)	-40°C...+125°C	ETIM 7.0	EC002314
		Packaging Information	
		Sub-packaging length	167,00 mm
		Sub-packaging height	21,00 mm
		Sub-packaging width	60,00 mm
		Sub-packaging weight	0,16 kg
		Sub-packaging volume	0,21 dm ³
		Sub-packaging description	Carton tray
		Sub-packaging quantity	1 Pcs
		Sub-packaging EAN barcode	8015747292672

Part number

CGC 16 G



Catalogue drawings

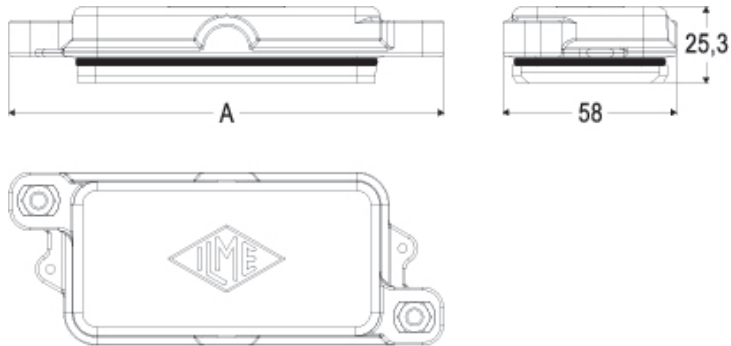

part No.	polarity	A
CGC 06 G	06	132,5
CGC 10 G	10	145,5
CGC 16 G	16	165,5
CGC 24 G	24	192,5

Catalogue drawings

Loop, for fixing on hoods

