

Part number

CAP 16.29

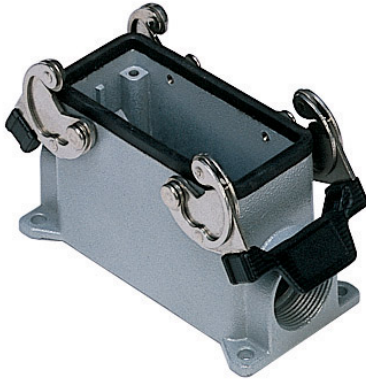

Surface mounting housing, C-TYPE series, with 2 levers, Pg29 cable entry, size "77.27", high construction



Product description

Product type	Surface mounting housing
Series	C-TYPE
Closing type	With 2 levers
Size	Size 77.27
Cable entry	With cable entry Pg29
Specification	High construction

Technical data

IP degree of protection IP65 / IP66 / IP69

Further technical details

Weight	390,00 g
Operating temperature range (min, max)	-40°C...+125°C

Material properties

Other materials	Lever: Stainless steel, polyamide (PA) Gasket: NBR
Colour	RAL 7040 grey
RoHs conformity	Compliant
China RoHs - EFUP	E
REACH SVHC substances	No

Approvals / Standards

Certifications	DNV, BV
UL	ECBT2
cUL	ECBT8

General ordering information

EAN13 code 8015747008266

Packaging Information

Packaging length	475,00 mm
Packaging height	220,00 mm
Packaging width	175,00 mm
Packaging weight	3,90 kg
Packaging volume	18,29 dm ³
Packaging description	Carton box
Packaging quantity	10 Pcs
Packaging EAN code	8015747236782
Sub-packaging weight	1,95 kg
Sub-packaging description	Plastic packaging
Sub-packaging quantity	5 Pcs
Sub-packaging EAN barcode	8015747008273

Part number

CAP 16.29



Catalogue drawings

CHP CAP - MHP MAP



CHP CS/CP CAP CS/CP - MHP CS/CP MAP CS/CP

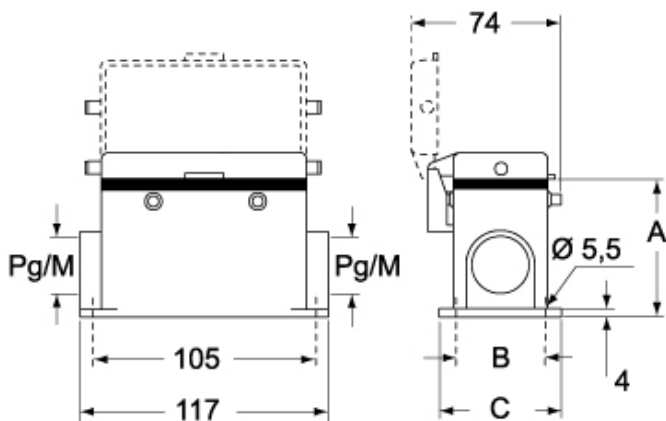

	A
CHP / MHP	63
CAP / MAP	77
CHP CS / MHP CS	63
CAP CS / MAP CS	77
CHP CP / MHP CP	63
CAP CP / MAP CP	77