

Part number

CAOS 16.29



Hood, EMC series, with 2 pegs, Pg29 side cable entry, size "77.27", high construction

Product description

Product type	Hood
Series	EMC
Closing type	With 2 pegs
Size	Size 77.27
Cable entry	Side cable entry Pg29
Specification	High construction

Technical data

IP degree of protection IP65 / IP66 / IP69

Further technical details

Weight	193,00 g
Operating temperature range (min, max)	-40°C...+125°C

Material properties

RoHs conformity	Compliant
China RoHs - EFUP	E
REACH SVHC substances	No

Approvals / Standards

Certifications	DNV, BV
UL	ECBT2
cUL	ECBT8

General ordering information

EAN13 code 8015747138093

Packaging Information

Packaging length	255,00 mm
Packaging height	150,00 mm
Packaging width	180,00 mm
Packaging weight	2,10 kg
Packaging volume	6,89 dm ³
Packaging description	Carton box
Packaging quantity	10 Pcs
Packaging EAN code	8015747231688
Sub-packaging weight	0,21 kg
Sub-packaging description	Plastic packaging
Sub-packaging quantity	1 Pcs
Sub-packaging EAN barcode	8015747140010

Part number

CAOS 16.29



Catalogue drawings

CHOS (CAOS) - MHOS (MAOS)

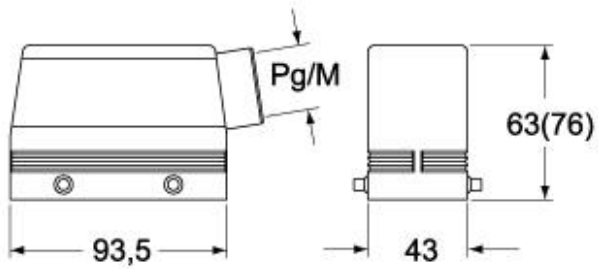

CHVS (CAVS) - MHVS (MAVS)

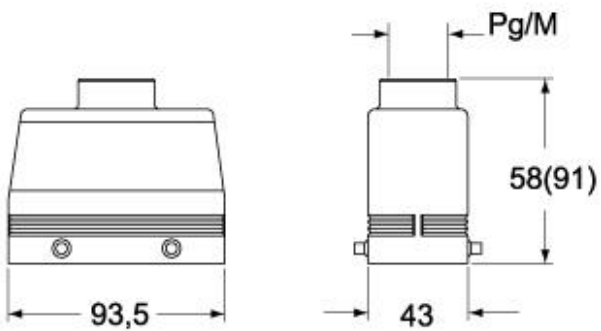

CHCS G

