

Part number

# C30MA 95 P



Male crimp contact, C30 series, 300 A, turned silver plated, wire cross section 95 mm<sup>2</sup>, AWG 3/0, finger-proof version

Product description		Material properties	
<b>Product type</b>	Crimp contact	<b>Main material</b>	Copper alloy
<b>Series</b>	C30	<b>Other materials</b>	Cap: polycarbonate (PC)
<b>Gender</b>	Male		Compliant with exemption 6(c): copper alloy containing up to 4% lead by weight
<b>Specification</b>	Finger-proof version	<b>RoHs conformity</b>	
Technical data		<b>China RoHs - EFUP</b>	50
<b>Current</b>	300 A	<b>REACH SVHC substances</b>	Yes Lead
<b>Wire cross-section</b>	95,00 mm <sup>2</sup>	General ordering information	
<b>Contact type</b>	Turned silver plated	<b>EAN13 code</b>	8015747290968
Further technical details		Packaging Information	
<b>Contact resistance</b>	≤ 0,2 mΩ	<b>Packaging length</b>	112,00 mm
<b>Weight</b>	48,00 g	<b>Packaging height</b>	95,00 mm
<b>Conductors stripping length</b>	22,5 mm	<b>Packaging width</b>	117,00 mm
		<b>Packaging volume</b>	1,24 dm <sup>3</sup>
		<b>Packaging description</b>	Carton box
		<b>Packaging quantity</b>	40 Pcs
		<b>Packaging EAN code</b>	8015747290975
		<b>Sub-packaging description</b>	Plastic box
		<b>Sub-packaging quantity</b>	5 Pcs
		<b>Sub-packaging EAN barcode</b>	8015747290982

Part number

# C30MA 95 P



Catalogue drawings

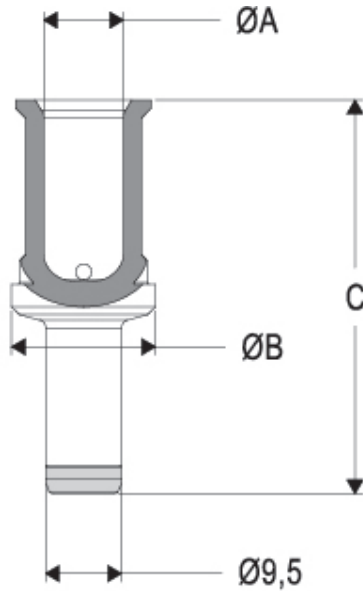

## C30MA..P contacts

conductor section (mm <sup>2</sup> )	conductor slot $\varnothing A$ (mm)	$\varnothing B$ (mm)	C (mm)	conductor stripping length (mm)
16	5,5	18	42,7	19
25	7	18	42,7	19
35	8,2	18	43,7	20
50	10	18	49,2	22,5
70	11,5	18	49,2	22,5
95	13,5	21	49,2	22,5
120	15,5	21	49,2	22,5