

Part number

BK 16115



Interlocked switched socket-outlet, BK series, 3 poles + N + PE, 11 h (red), 16 A, 250/440 ÷ 265/460 V, sectionable fuse carrier 10 x 38 mm

Product description

Product type	Interlocked switched socket-outlet
Series	BK
N. of poles	3 poles + N + 
Clock position	11
Specification	Sectionable fuse carrier 10 x 38 mm

Technical data

Current	16 A
Voltage	250/440V ÷ 265/460V
IP degree of protection	IP67

Further technical details

Operating temperature range (min, max)	-25°C ... +40°C
IK rating (impact degree of protection)	IK10

Material properties

Colour	RAL 7035 grey, RAL 3000 red
---------------	-----------------------------

Approvals / Standards

Reference standard	EN 60309-1, -2 e -4
---------------------------	---------------------

General ordering information

EAN13 code	8015747147088
-------------------	---------------

Part number

BK 16115



Catalogue drawings

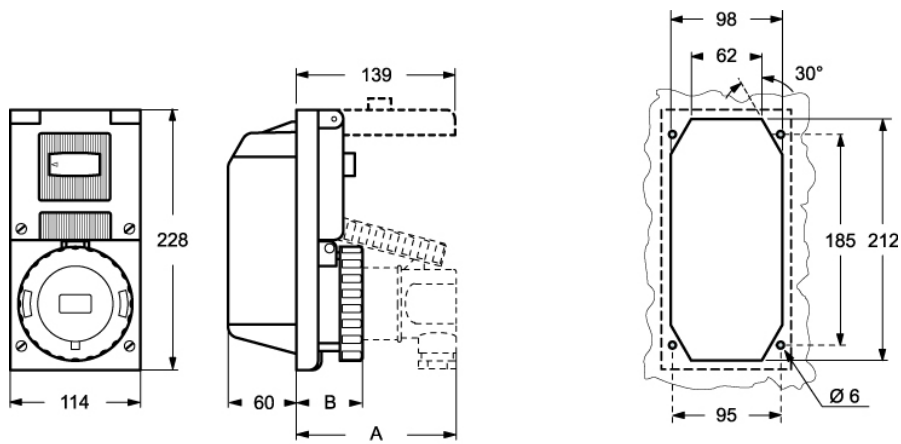

BK		A	B
16A	2P + ⊕	105	50
	3P + ⊕	105	50
	3P + N + ⊕	110	50
32A	2P + ⊕	140	58
	3P + ⊕	140	58
	3P + N + ⊕	140	58