

Part number

TM 1456 TB



Modular back plate for socket outlets set mounting, TM series

Product description

Product type	Modular back plate for socket outlets set mounting
Series	TM
Size	145 x 565 x 18 mm

Further technical details

Weight	520,00 g
Operating temperature range (min, max)	-25°C ... +40°C
IK rating (impact degree of protection)	IK10

Material properties

Colour	RAL 7012 grey
---------------	---------------

General ordering information

EAN13 code	8015747089463
-------------------	---------------

Packaging Information

Packaging length	310,00 mm
Packaging height	120,00 mm
Packaging width	585,00 mm
Packaging weight	5,20 kg
Packaging volume	21,76 dm ³
Packaging description	Carton box
Packaging quantity	10 Pcs
Packaging EAN code	8015747089470
Sub-packaging weight	0,52 kg
Sub-packaging description	Plastic packaging
Sub-packaging quantity	1 Pcs
Sub-packaging EAN barcode	8015747089487

Part number

TM 1456 TB



Catalogue drawings

TM 1145 TB

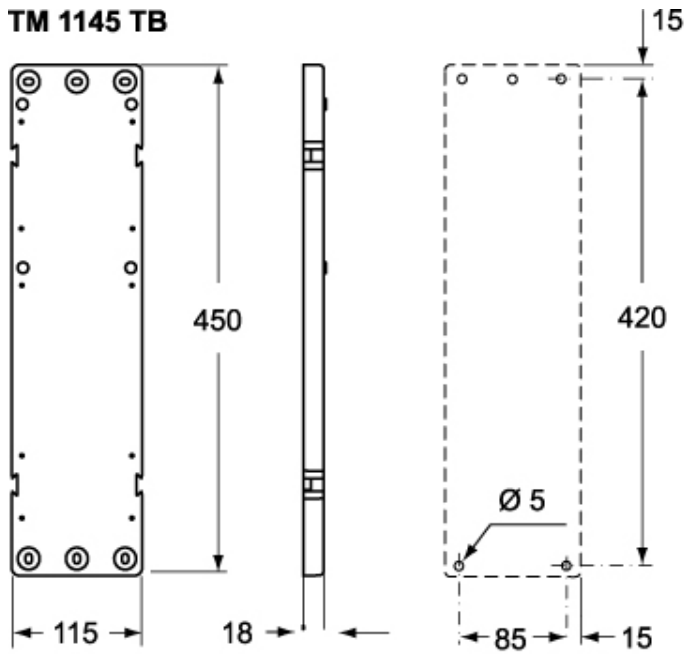

TM 1456 TB

