

Part number

TM 1114 DB



Box, TM series, with fixed cover, for TM 1145 TB plate

Product description		Material properties	
Product type	Box	Colour	RAL 7012 grey
Series	TM		Compliant with exemption
Specification	With fixed cover For TM 1145 TB plate	RoHs conformity	6(c): copper alloy containing up to 4% lead by weight
Technical data		China RoHs - EFUP	50
IP degree of protection	IP66 / IP67		Yes
Further technical details		REACH SVHC substances	Lead
Weight	413,00 g	SCIP number	B0214dad-d2d9-4e91-a5b4-f4c9b4612083
Operating temperature range (min, max)	-25°C ... +40°C	General ordering information	
IK rating (impact degree of protection)	IK10	EAN13 code	8015747089180
		Packaging Information	
		Packaging length	310,00 mm
		Packaging height	265,00 mm
		Packaging width	500,00 mm
		Packaging weight	8,80 kg
		Packaging volume	41,08 dm ³
		Packaging description	Carton box
		Packaging quantity	20 Pcs
		Packaging EAN code	8015747089197
		Sub-packaging weight	0,44 kg
		Sub-packaging description	Plastic packaging
		Sub-packaging quantity	1 Pcs
		Sub-packaging EAN barcode	8015747089203

Part number

TM 1114 DB



Catalogue drawings

TM 1114 DB

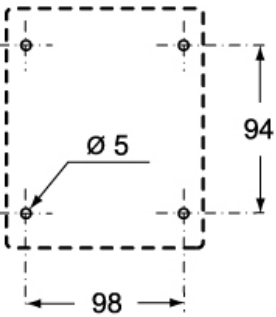
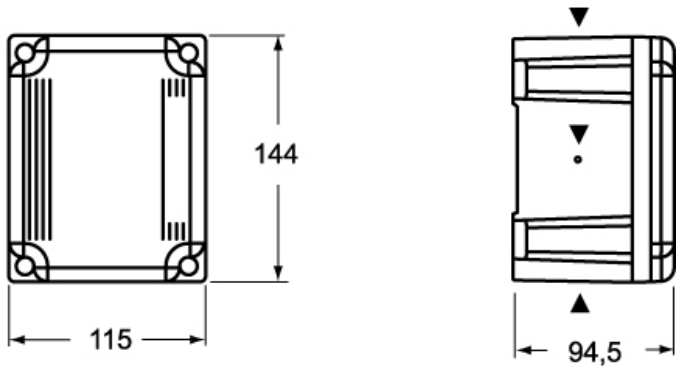

TM 1414 DB

