

Part number

SQV 3293.5



Interlocked switched socket-outlet, SQV series, 2 poles + PE, 9 h (red), 32 A, 380 ÷ 415 V, sectionable fuse carrier 10 x 38 mm

Product description

Product type	Interlocked switched socket-outlet
Series	SQV
N. of poles	2 poles + 
Clock position	9
Size	Socket fixing centre distance 88 x 230 mm
Specification	Sectionable fuse carrier 10 x 38 mm

Technical data

Current	32 A
Voltage	380 ÷ 415 V
IP degree of protection	IP55

Further technical details

Weight	685,00 g
Operating temperature range (min, max)	-25°C ... +40°C
IK rating (impact degree of protection)	IK08

Material properties

Colour	RAL 7035 grey, RAL 3000 red
RoHs conformity	Compliant with exemption 6(c): copper alloy containing up to 4% lead by weight
China RoHs - EFUP	50
REACH SVHC substances	Yes Lead
SCIP number	F6799547-ab84-42f2-938f-233ba663766d

Approvals / Standards

Reference standard	EN 60309-1, -2 e -4
---------------------------	---------------------

General ordering information

EAN13 code	8015747089029
-------------------	---------------

Packaging Information

Sub-packaging length	116,00 mm
Sub-packaging height	103,00 mm
Sub-packaging width	230,00 mm
Sub-packaging weight	0,69 kg
Sub-packaging volume	2,75 dm ³
Sub-packaging description	Carton box
Sub-packaging quantity	1 Pcs
Sub-packaging EAN barcode	8015747089036

Part number

SQV 3293.5



Catalogue drawings

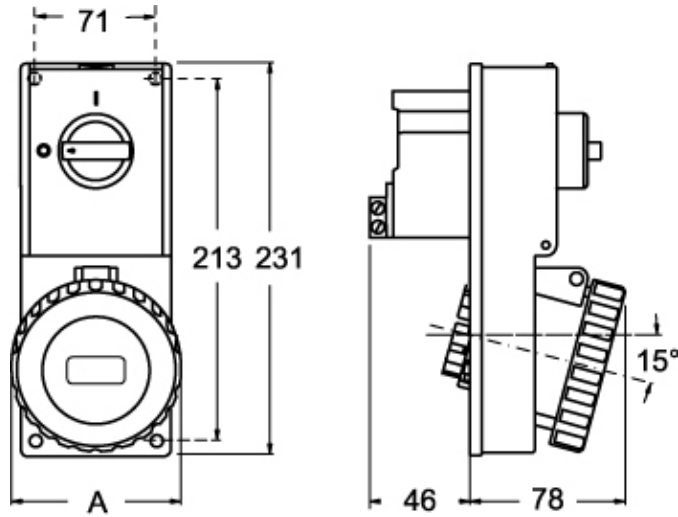

Catalogue drawings



SQV.5		A
32A	2P+⊕	92
	3P+⊕	92
	3P+N+⊕	100