

Part number

SQE 1635.5



Interlocked switched socket-outlet, SQE series, 3 poles + N + PE, 3 h (red), 16 A, 220/380 V, without fuse-carrier

Product description	
Product type	Interlocked switched socket-outlet
Series	SQE
N. of poles	3 poles + N + 
Clock position	3
Specification	Without fuse-carrier
Technical data	
Current	16 A
Voltage	220/380V (50Hz) 250/440V (60Hz)
IP degree of protection	IP55
Further technical details	
Operating temperature range (min, max)	-25°C ... +40°C
IK rating (impact degree of protection)	IK08

Material properties	
Colour	RAL 7035 grey, RAL 3000 red
Approvals / Standards	
Reference standard	EN 60309-1, -2 e -4
General ordering information	
EAN13 code	8015747159876

Part number

SQE 1635.5



Catalogue drawings

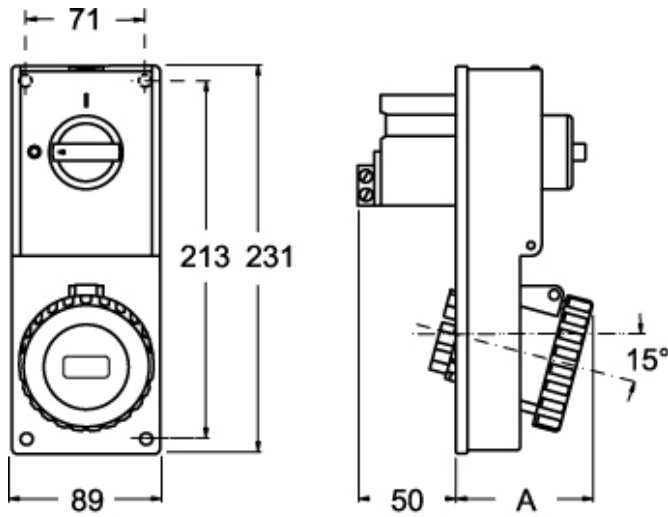

Catalogue drawings

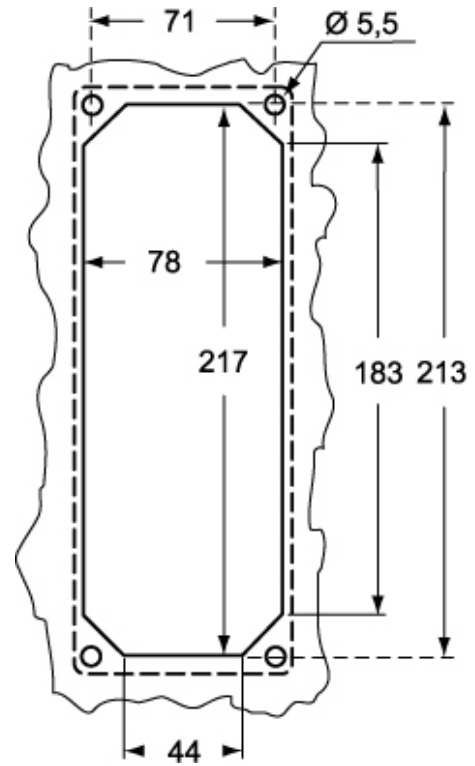

SQE.5		A
16A	2P+⊕	67
	3P+⊕	67
	3P+N+⊕	70