

Part number

SIF2D 0.5R

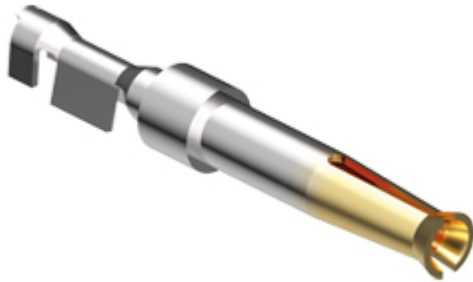

Female crimp contact, SI series, 5 A, stamped gold plated, wire cross section 0,21 - 0,52 mm², AWG 24 - 20, reel packaging, for 250 mating cycles

Product description		Material properties	
Product type	Crimp contact	RoHs conformity	Compliant
Series	SI	China RoHs - EFUP	E
Gender	Female	REACH SVHC substances	No
Specification	Reel packaging For 250 mating cycles	Approvals / Standards	
Technical data		Certifications	EAC
Current	5 A	UL	ECBT2
Wire cross-section	0,21 mm ² - 0,52 mm ²	cUL	ECBT8
AWG size	24 - 20	General ordering information	
Contact type	Stamped gold plated	EAN13 code	8015747272407
Further technical details		eCl@ss 8.1	27440204
Contact resistance	≤ 10 mΩ	ETIM 7.0	EC000796
Weight	0,20 g	Packaging Information	
Conductors stripping length	3 mm	Packaging weight	2,17 kg
		Packaging description	Plastic bag
		Packaging quantity	10000 Pcs
		Packaging EAN code	8015747274012

Part number

SIF2D 0.5R



Catalogue drawings

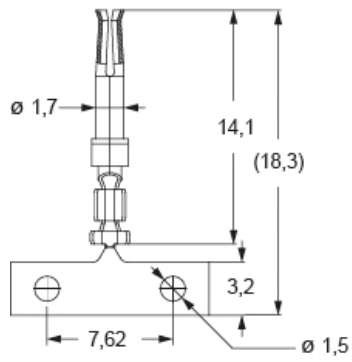

SIF..D R

Reel unrolling left

