

Part number

# PEW 6363 PP



Wall-mounting socket outlet, PLUSO series, 2 poles + PE, 6 h (blue), 63 A, 200 ÷ 250 V

#### Product description

<b>Product type</b>	Socket Wall-mounting
<b>Series</b>	PEW...PP, PLUSO
<b>N. of poles</b>	2 poles + 
<b>Clock position</b>	6

#### Technical data

<b>Current</b>	63 A
<b>Voltage</b>	200 ÷ 250 V
<b>IP degree of protection</b>	IP67

#### Further technical details

<b>Weight</b>	1.296,00 g
<b>Operating temperature range (min, max)</b>	-25°C ... +40°C

#### Material properties

<b>Colour</b>	RAL 7035 grey, RAL 5015 blue
<b>RoHs conformity</b>	Compliant with exemption 6(c): copper alloy containing up to 4% lead by weight
<b>China RoHs - EFUP</b>	50
<b>REACH SVHC substances</b>	Yes Lead
<b>SCIP number</b>	Ca7de37f-add8-4b77-9861-279c94903ade

#### Approvals / Standards

<b>Reference standard</b>	EN 60309-1 and -2
---------------------------	-------------------

#### General ordering information

<b>EAN13 code</b>	8015747077323
-------------------	---------------

#### Packaging Information

<b>Packaging length</b>	210,00 mm
<b>Packaging height</b>	135,00 mm
<b>Packaging width</b>	280,00 mm
<b>Packaging weight</b>	1,54 kg
<b>Packaging volume</b>	7,94 dm <sup>3</sup>
<b>Packaging description</b>	Carton box
<b>Packaging quantity</b>	1 Pcs
<b>Packaging EAN code</b>	8015747077330

Part number

# PEW 6363 PP



Catalogue drawings

(63A) PEW ... PP

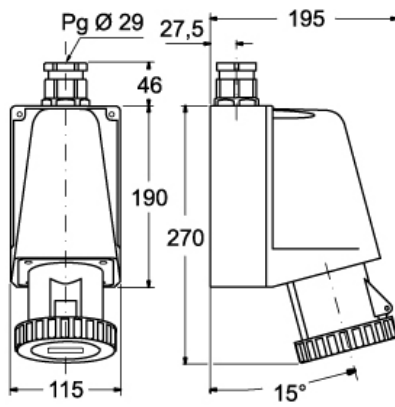

(125A) PEW ... PP

