

Part number

PEW 1694 SI



Flush-mounting plug, PLUSO series, 3 poles + PE, 9 h (blue), 16 A, 200 ÷ 250 V

Product description		Material properties	
Product type	Plug Flush-mounting	Colour	RAL 7035 grey, RAL 5015 blue
Series	PEW...SI, PLUSO	RoHs conformity	Compliant with exemption 6(c): copper alloy containing up to 4% lead by weight
N. of poles	3 poles + 	China RoHs - EFUP	50
Clock position	9	REACH SVHC substances	Yes Lead
Size	Fixing centre distance socket 52 x 60 mm	SCIP number	Ca7de37f-add8-4b77-9861-279c94903ade
Technical data		Approvals / Standards	
Current	16 A	Reference standard	EN 60309-1 and -2
Voltage	200 ÷ 250 V	General ordering information	
IP degree of protection	IP67	EAN13 code	8015747073851
Further technical details		Packaging Information	
Weight	166,00 g	Packaging length	285,00 mm
Operating temperature range (min, max)	-25°C ... +40°C	Packaging height	170,00 mm
		Packaging width	190,00 mm
		Packaging weight	1,89 kg
		Packaging volume	9,21 dm ³
		Packaging description	Carton box
		Packaging quantity	10 Pcs
		Packaging EAN code	8015747073868

Part number

PEW 1694 SI



Catalogue drawings

(16 / 32A) PEW ... SI

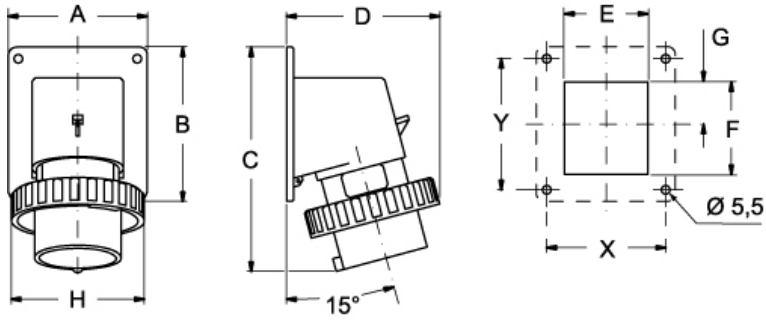

PEW ... SI	A	B	C	D	E	F	G	H	X	Y
16A 2P+⊕	65	82	126	81	41	43	21,5	70	52	60
3P+⊕	65	82	126	81	47	43	24,5	78	52	60
3P+N+⊕	90	100	146	93	54	60	27,5	86	77	85
32A 2P+⊕	90	100	160	101	55	60	27,5	92	77	85
3P+⊕	90	100	160	101	55	60	27,5	92	77	85
3P+N+⊕	90	100	160	101	62	60	27,5	100	77	85